

1.
NOT MEASUREMENT
SENSITIVE

MIL-HDBK-1110
17 JANUARY 1995
SUPERSEDING
NAVFAC MO-110
JUNE 1981

MILITARY HANDBOOK

HANDBOOK FOR PAINTS AND PROTECTIVE COATINGS
FOR FACILITIES



AMSC N/A

AREA FACR

DISTRIBUTION STATEMENT A. Approved for public release; distribution is unlimited.

ABSTRACT

This handbook is provided as guidance for DOD personnel wishing to apply architectural paints or protective coatings to military structures fixed in place. It is not for use with ships, aircraft, or automotive vehicles. It is written for general use by both those with much and with little knowledge of the use of paint and coating materials. It contains information on the composition of coatings, their mechanisms of curing, environmental and safety concerns, necessary surface preparation, selection for different substrates and structures, application, inspection, and failure analysis.

FOREWORD

This handbook identifies criteria and procedures for applying architectural paints or protective coatings to military structures fixed in place.

Recommendations for improvements are encouraged from Government agencies and the private sector and should be furnished on the DD Form 1426 provided inside the back cover to Commanding Officer, Northern Division, Naval Facilities Engineering Command, Code 164, 10 Industrial Highway, Mail Stop 82, Lester, PA 19113-2090; Telephone: Commercial (610) 595-0661/DSN 443-0661.

THIS HANDBOOK SHALL NOT BE USED AS A REFERENCE DOCUMENT FOR PROCUREMENT OF FACILITIES CONSTRUCTION. IT IS TO BE USED AS A MAINTENANCE MANAGEMENT TOOL BY PUBLIC WORKS DEPARTMENTS, PUBLIC WORKS CENTERS, BASE CIVIL ENGINEERS, AND FACILITIES ENGINEERS. DO NOT REFERENCE IT IN MILITARY OR FEDERAL SPECIFICATIONS OR OTHER PROCUREMENT DOCUMENTS.

THIS PAGE INTENTIONALLY LEFT BLANK

HANDBOOK FOR PAINTS AND PROTECTIVE COATINGS FOR FACILITIES

CONTENTS

		<u>Page</u>
Section 1	INTRODUCTION	
1.1	Purpose.....	1
1.2	Scope.....	1
1.3	Deterioration of Facilities.....	1
1.3.1	Corrosion of Metals.....	1
1.3.2	Deterioration of Wood.....	2
1.3.3	Deterioration of Concrete.....	2
1.3.4	Design Factors Affecting Deterioration.....	2
1.3.4.1	Water Traps.....	2
1.3.4.2	Crevices.....	3
1.3.4.3	Rough and Sharp Surfaces.....	3
1.3.4.4	Limited Access to Work.....	3
1.3.4.5	Incompatible Environment.....	3
1.3.4.6	Contact of Dissimilar Metals.....	3
1.4	Control of Facilities Deterioration.....	4
1.4.1	Corrosion Control by Coatings.....	4
1.4.1.1	Barrier Protection.....	4
1.4.1.2	Inhibitive Pigments.....	4
1.4.1.3	Cathodic Protection.....	4
1.5	Painting for Purposes Other Than Protection	5
1.5.1	Cosmetic Appearance.....	5
1.5.2	Marking Paints.....	5
1.5.3	Safety Colors and Designs.....	5
1.5.4	Reflective Finishes.....	5
1.5.5	Nonskid Surfaces.....	5
1.5.6	Antifouling Coatings.....	6
Section 2	COATING COMPOSITIONS AND CURING MECHANISMS	
2.1	Coating Composition.....	7
2.1.1	Solvent.....	7
2.1.2	Resin.....	7
2.1.3	Pigment.....	8
2.1.4	Other Components.....	10
2.1.5	Spreading Rate.....	10
2.2	Mechanisms of Curing of Coatings.....	10
2.2.1	Air Oxidation of Drying Oils.....	11
2.2.2	Solvent of Water Evaporation.....	12
2.2.3	Chemical Reaction.....	13
2.3	Properties of Different Generic Types of Coatings.....	14
2.3.1	Alkyds and Other Oil-Containing Coatings...	14
2.3.2	Water Emulsion (Latex) Coatings.....	15
2.3.3	Lacquers.....	16
2.3.4	Epoxy Coatings.....	17

		<u>Page</u>
2.3.5	Coal-Tar Epoxy Coatings.....	18
2.3.6	Polyurethane Coatings.....	18
2.3.7	Polyester Coating.....	19
2.3.8	Inorganic Zinc Coatings.....	19
2.3.9	Zinc-Rich Organic Coatings.....	20
2.4	Coating Compatibility.....	20
2.4.1	Bleeding.....	21
2.4.2	Disbonding of Old Paint.....	21
2.4.3	Topcoat Checking.....	21
2.4.4	Poor Adhesion of Latex Topcoats to Enamels..	21
2.4.5	Oil-Based Paints Applied to Alkaline Surfaces.....	21
Section 3	ENVIRONMENTAL, OCCUPATIONAL, AND SAFETY ISSUES	
3.1	Introduction.....	23
3.2	Material Composition Issues.....	23
3.2.1	VOC Restrictions.....	23
3.2.1.1	Definition of VOC.....	23
3.2.1.2	Types of Regulations.....	23
3.2.1.3	Effect on Coatings.....	24
3.2.2	Application Issues.....	25
3.2.3	Toxic Solvents.....	25
3.2.4	Hazardous Air Pollutants.....	26
3.2.5	Binders - Polyurethanes, Coal Tars, Asphalts	26
3.2.6	Heavy Metal-Containing Pigments and Additives.....	26
3.3	Issues Affecting Surface Preparation.....	28
3.3.1	Regulations.....	28
3.3.2	Waste.....	29
3.4	Surfaces Coated With Lead-Based Paint.....	29
3.4.1	Background.....	29
3.4.1.1	Use of Lead in Paint.....	29
3.4.1.2	Effects of Lead Exposure on Health.....	30
3.4.1.3	Environmental Issues.....	30
3.4.1.4	Occupational Safety Issues.....	30
3.4.2	Definitions.....	31
3.4.3	DOD Policy/Instruction.....	31
3.4.3.1	Residential Structures.....	31
3.4.3.2	Non-Residential.....	32
3.4.4	General Description of Lead-Based Paint Procedures.....	33
3.4.4.1	Inspection/Assessment.....	33
3.4.4.2	In-Place Management (IPM).....	33
3.4.4.3	Removal.....	34
3.4.4.4	Operations and Maintenance.....	34
3.4.5	Waste Disposal.....	35
3.4.6	Demolition of Buildings Containing Lead-Based Paint.....	35
3.4.7	Sources of Detailed Information.....	35

		<u>Page</u>
Section 4	SELECTION OF COATINGS	
4.1	Available Guidance.....	36
4.2	Selection Criteria.....	36
4.2.1	Desired Film Properties.....	36
4.2.2	Work Requirements or Limitations.....	36
4.2.3	Safety and Environmental Restrictions.....	37
4.2.4	Compatibilities.....	37
4.2.5	Costs.....	37
4.3	Specifications for Lead- and Chromate-Free Coatings With VOC Limits.....	38
4.4	Recommendations for Different Substrates...	39
4.4.1	Recommendations for Wood.....	40
4.4.1.1	Oil-Based Paints.....	40
4.4.1.2	Water-Emulsion Paints.....	40
4.4.1.3	Semi-Transparent Stains.....	41
4.4.1.4	Clear Floor Finishes.....	41
4.4.2	Recommendations for Concrete and Masonry Surfaces.....	41
4.4.2.1	Waterborne Coatings.....	41
4.4.2.2	Elastomeric Coatings.....	42
4.4.2.3	Textured Coatings.....	42
4.4.2.4	Epoxy Coatings.....	43
4.4.3	Recommendations for Steel.....	43
4.4.3.1	Alkyd Systems.....	44
4.4.3.2	Epoxy Coating Systems.....	44
4.4.3.3	Zinc-Rich Coatings.....	45
4.4.4	Recommendations for Galvanized Steel.....	45
4.4.4.1	Epoxy Systems.....	46
4.4.4.2	Waterborne System for Galvanizing.....	46
4.4.5	Recommendations for Aluminum.....	46
Section 5	COATING SYSTEMS FOR SPECIFIC USES	
5.1	General.....	48
5.2	Painting New Construction.....	48
5.3	Fuel Storage Tanks.....	48
5.3.1	Interiors of Steel Fuel Tanks.....	49
5.3.2	Exteriors of Steel Fuel Tanks.....	50
5.4	Steel Water Tanks.....	50
5.4.1	Interiors of Steel Water Tanks.....	51
5.4.2	Exteriors of Steel Water Tanks.....	51
5.5	Other Steel Tanks.....	51
5.5.1	Interiors of Other Steel Tanks.....	51
5.5.2	Exteriors of Other Steel Tanks.....	51
5.6	Steel Distribution Lines.....	51
5.6.1	Steel Fuel Lines.....	51
5.6.1.1	Buried Steel Fuel Lines.....	51
5.6.1.2	Immersed Steel Fuel Lines.....	53
5.6.1.3	Aboveground Fuel Lines.....	53

		<u>Page</u>
5.6.2	Steel Water Distribution Lines.....	53
5.7	Communication Towers and Other Tall Structures.....	53
5.7.1	New Towers.....	54
5.7.1.1	New Galvanized Steel Towers.....	54
5.7.1.2	New Thermally Sprayed Steel Towers.....	55
5.7.1.3	New Steel Towers.....	55
5.7.2	Existing Towers.....	55
5.7.2.1	Towers With Only Cosmetic Coating Defects...	56
5.7.2.2	Zinc-Coated Steel Tower Components With Deteriorated Organic Coatings.....	57
5.7.2.3	Steel Tower Components (With No Zinc Coating) With Damaged Organic Coating.....	57
5.7.3	Galvanized Steel Guy Lines for Towers.....	58
5.8	Waterfront Structures.....	58
5.9	Hydraulic Structures and Appurtenant Works..	58
5.10	Factory Finished Metal Siding.....	59
5.11	Chain Link Fences.....	59
5.12	Hot Steel Surfaces.....	59
5.13	Concrete Fuel Tanks.....	59
5.14	Concrete Swimming Pools.....	60
5.15	Concrete Catchment Basins.....	61
5.16	Chemically Resistant Finishes for Concrete Floors.....	61
5.17	Slip-Resistant Floors.....	62
5.18	Fouling-Resistant Coatings.....	62
5.19	Mildew-Resistant Coatings.....	62
5.19.1	Factors Affecting Mildew Growth.....	62
5.19.2	Use of Mildewcides in Paints.....	63
5.19.3	Removal of Mildew.....	63
5.20	Pavement Markings.....	63
5.20.1	Painted Markings.....	64
5.20.1.1	Specifications for Marking Paints.....	64
5.20.1.2	Specification for Reflective Glass Beads....	65
5.20.1.3	Application of Painted Markings.....	65
5.20.1.4	Inspection of Marking Operation.....	66
5.20.2	Alternative Markings.....	71
5.21	Wooden Floors.....	71
Section 6	SURFACE PREPARATION	
6.1	Introduction.....	72
6.1.1	Selection Factors.....	72
6.1.2	Specification Procedure.....	72
6.1.3	Section Organization.....	72
6.2	Repair of Surfaces.....	73
6.2.1	Joints, Cracks, Holes, or Other Surface Defects.....	73

	<u>Page</u>
6.2.2	Cementitious Surfaces..... 74
6.3	Recommendations By Substrate..... 74
6.3.1	Wood..... 74
6.3.2	Concrete/Masonry..... 76
6.3.3	Steel..... 76
6.3.3.1	Specific Surface Preparation Requirements for Coatings for Steel..... 77
6.3.4	Galvanized and Inorganic-Zinc Primed Steel.. 77
6.3.5	Aluminum and Other Soft Metals..... 78
6.4	Standards for Condition of Substrates..... 78
6.4.1	Unpainted Steel..... 78
6.4.2	Nonferrous Unpainted Substrates..... 79
6.5	Standards for Cleanliness of Substrates..... 79
6.5.1	Standards for Cleaned Steel Surfaces..... 79
6.5.1.1	SSPC and NACE Definitions and Standards..... 79
6.5.1.2	Job-Prepared Standard..... 79
6.5.1.3	Pictorial Standards for Previously Painted Steel..... 79
6.5.2	Standards for Cleaned Nonferrous Metals..... 80
6.5.3	Previously Coated Surfaces..... 80
6.6	Recommendations for Paint Removal..... 81
6.7	Methods of Surface Preparation..... 81
6.7.1	Abrasive Blasting..... 81
6.7.1.1	Types of Abrasive Blasting..... 82
6.7.1.2	Conventional Abrasive Blasting Equipment.... 84
6.7.1.3	Abrasive Properties..... 87
6.7.1.4	Abrasive Types..... 88
6.7.1.5	Selection..... 91
6.7.1.6	Inspection..... 91
6.7.1.7	Procedures/General Information..... 92
6.7.2	Acid Cleaning..... 92
6.7.2.1	Concrete..... 94
6.7.3	Chemical Removal of Paint..... 94
6.7.4	Detergent Washing..... 95
6.7.5	Hand Tool Cleaning..... 95
6.7.6	Heat..... 95
6.7.7	Organic Solvent Washing..... 96
6.7.8	Power Tool Cleaning..... 96
6.7.9	Steam Cleaning..... 97
6.7.10	Water Blast Cleaning..... 97
6.7.10.1	Equipment..... 98
 Section 7 APPLICATION	
7.1	Introduction..... 99
7.2	Paint Storage Prior to Application..... 99
7.3	Preparing Paint for Application..... 99
7.3.1	Mixing..... 99
7.3.1.1	Mixing Two-Component Coatings.....100

		<u>Page</u>
7.3.2	Thinning.....	103
7.3.3	Tinting.....	103
7.3.4	Straining.....	103
7.4	Weather Conditions Affecting Application of Paints.....	103
7.4.1	Temperature.....	104
7.4.2	Humidity.....	104
7.4.3	Wind.....	104
7.4.4	Moisture.....	104
7.5	Methods of Application.....	105
7.5.1	Selection of Application Method.....	105
7.5.2	Brush Application.....	105
7.5.2.1	Procedure for Brush Application.....	106
7.5.3	Roller Application.....	107
7.5.3.1	Procedures for Roller Application.....	108
7.5.4	Spray Application.....	109
7.5.4.1	Conventional or Air Spray Equipment.....	109
7.5.4.2	Airless Spray.....	115
7.5.4.3	Air-Assisted Airless Spray.....	117
7.5.4.4	High-Volume, Low-Pressure Spray.....	117
7.5.4.5	Multi-Component Spray.....	117
7.5.4.6	Electrostatic Spray.....	118
7.5.4.7	Powder Spraying.....	118
7.5.4.8	Thermal Spraying.....	118
7.5.4.9	Application Technique.....	119
Section 8	PREPARATION OF A PAINTING CONTRACT SPECIFICATION	
8.1	General.....	128
8.2	Background.....	128
8.3	The CSI Format.....	129
8.3.1	General Information Part.....	129
8.3.1.1	Summary Section.....	130
8.3.1.2	Reference Section.....	130
8.3.1.3	Definition Section.....	131
8.3.1.4	Submittals Section.....	131
8.3.1.5	Quality Assurance Section.....	133
8.3.1.6	Delivery, Storage, Handling, and Disposal..	133
8.3.1.7	Site Conditions.....	134
8.3.2	Products Part.....	134
8.3.3	Execution Part.....	135
8.3.3.1	Work Conditions.....	135
8.3.3.2	Surface Preparation.....	136
8.3.3.3	Coating Application.....	136
8.3.3.4	Inspection.....	136
8.4	Language to be Used in Specification.....	137
8.4.1	Concise Words.....	137
8.5	Construction Criteria Base.....	138

		<u>Page</u>
Section 9	INSPECTION OF PAINTING OPERATIONS	
9.1	Scope of Section.....	139
9.2	Importance of Inspection.....	139
9.3	Contractor Quality Control Inspection.....	139
9.4	Duties of an Inspector.....	139
9.4.1	Record Keeping.....	140
9.5	Inspection Equipment.....	140
9.6	Inspection Steps.....	141
9.6.1	Review Specification and Correct Deficiencies, If Any.....	141
9.6.2	Visit Job Site.....	141
9.6.3	Conduct Pre-Construction Conference.....	146
9.6.4	Inspect Job Site After Pre-Surface Preparation.....	146
9.6.5	Inspect Coating Materials.....	146
9.6.6	Measure Ambient Conditions.....	147
9.6.6.1	Relative Humidity and Dew Point.....	149
9.6.6.2	Surface Temperature.....	149
9.6.7	Inspect Surface Preparation.....	149
9.6.7.1	Abrasive-Blasting Surface Preparation Equipment and Supplies.....	149
9.6.7.2	Water Blasting.....	150
9.6.7.3	Frequency of Inspecting Cleaned Surfaces....	151
9.6.7.4	Inspecting Prepared Steel Surfaces.....	151
9.6.7.5	Inspecting Concrete, Masonry, Wood, Plaster, Wallboard, Old Paint.....	152
9.6.8	Inspect Coating Application.....	152
9.6.8.1	Application Equipment.....	152
9.6.8.2	Ventilation.....	153
9.6.8.3	Mixing/Thinning.....	153
9.6.8.4	Film Thickness.....	153
9.6.8.5	Drying.....	154
9.6.9	Final Approval Procedures.....	154
9.6.10	Year Warranty Inspection.....	155
Section 10	FIELD INSPECTION INSTRUMENTS	
10.1	Introduction.....	156
10.2	Illuminated Microscope.....	156
10.3	Instruments for Use with Abrasive Blasting..	156
10.3.1	Gage for Determining Nozzle Pressure.....	156
10.3.2	Wedge for Determining Diameter of Nozzle Orifice.....	156
10.3.3	Surface Contamination Detection Kit.....	156
10.3.4	Profile of Blasted Steel.....	157
10.3.4.1	Comparators.....	157
10.3.4.2	Surface Profile Gages.....	157
10.3.4.3	Testex Press-O-Film Replicate Tape.....	157
10.3.5	Thermometers.....	157
10.3.6	Psychrometers.....	157

	<u>Page</u>
10.3.7	Wind Meter.....158
10.3.8	Moisture Meter.....158
10.3.9	Wet Film Gage.....158
10.3.9.1	Notched Metal Gage.....158
10.3.9.2	Cylindrical Gage.....159
10.3.10	Dry Film Thickness Gages for Coatings on Aluminum, Copper, and Stainless Steel.....159
10.3.11	Magnetic Dry Film Thickness Gages for Coatings on Steel.....159
10.3.11.1	Pull-Off Gages.....160
10.3.11.2	Flux Gages.....160
10.3.12	Destructive (Nonmagnetic Dry Film Thickness Gage).....161
10.3.13	Holiday Detector.....161
10.3.13.1	Low Voltage Holiday Detectors.....161
10.3.13.2	High Voltage Holiday Detectors.....162
10.3.14	Adhesion Tester.....162
10.3.14.1	Tape Adhesion Test.....162
10.3.14.2	Pull-Off Adhesion Test.....162
10.3.15	Portable Glossmeter.....163
10.3.16	Hardness Tester.....163
Section 11	ANALYSIS OF PAINT FAILURES
11.1	Definition.....164
11.2	Documentation of Findings.....164
11.3	Scope of Failure Analysis.....164
11.3.1	Review of Specification for Coating Work...165
11.3.2	Review of Supplier's Data.....165
11.3.3	Review of Inspector's Daily Reports.....165
11.3.4	On-Site Inspection.....165
11.3.5	On-Site Inspection Techniques.....166
11.3.6	Laboratory Testing.....167
11.3.6.1	Microscopic Examination.....167
11.3.6.2	Spot Tests.....167
11.3.6.3	Infrared Spectrophotometric Analysis.....167
11.3.6.4	Other Specialized Instrumentation.....168
11.3.7	Forming Conclusions and Preparing Reports...169
11.4	Expert System for Failure Analysis.....169
11.4.1	Cosmetic Defects.....170
11.4.1.1	Chalking.....170
11.4.1.2	Mildew.....170
11.4.1.3	Dirt.....170
11.4.1.4	Uneven Gloss.....170
11.4.1.5	Blushing.....170
11.4.1.6	Bleeding.....170
11.4.1.7	Fading.....171
11.4.1.8	Discoloration.....171

	<u>Page</u>
11.4.1.9	Pigment Overload.....171
11.4.1.10	Checking.....171
11.4.1.11	Dry Spray.....171
11.4.1.12	Sagging.....171
11.4.1.13	Orange Peel.....171
11.4.1.14	Wrinkling.....171
11.4.2	Film Failures.....172
11.4.2.1	Crawling.....172
11.4.2.2	Alligatoring.....172
11.4.2.3	Intercoat Delamination.....172
11.4.2.4	Intercoat Blistering.....172
11.4.2.5	Pinpoint Rusting.....172
11.4.2.6	Cracking.....172
11.4.2.7	Blistering to Substrate.....173
11.4.2.8	Peeling.....173
11.4.2.9	Flaking (Scaling).....173
11.4.3	Examples of Using Decision Trees.....173
11.4.3.1	Example of Surface Defect.....173
11.4.3.2	Example of a Film Defect.....173
Section 12	PROGRAMMING MAINTENANCE PAINTING
12.1	Definitions of Programmed Painting and Maintenance Painting.....176
12.2	Components of Programmed Painting.....176
12.2.1	Initial Design.....176
12.2.1.1	Structural Design.....176
12.2.1.2	Design of Coating System.....177
12.2.2	Plan for Monitoring Conditions of Structures and Their Protective Coatings....177
12.2.2.1	Determining the Type of Coating Failure....177
12.2.2.2	Determining the Extent of Coating Failure...177
12.2.2.3	Determining the Generic Type of the Finish Coat.....178
12.2.3	Types of Maintenance Painting.....178
12.2.4	Plan for Maintenance Painting.....180
12.2.4.1	Selecting Materials for Maintenance Painting.....180
12.2.4.2	Surface Preparation for Maintenance Painting.....180
12.2.4.3	Application for Maintenance Painting.....181
12.2.4.4	Inspection of Maintenance Painting.....181
12.2.5	Scheduling the Work.....181
Section 13	GENERAL SAFETY PRACTICES DURING PAINTING OPERATIONS
13.1	Introduction.....182
13.2	Standard Operation and Safety Plans.....182

	<u>Page</u>
13.3	Hazard Communication.....182
13.3.1	Labels.....183
13.3.2	Material Safety Data Sheets.....183
13.4	Toxicity Hazards.....183
13.4.1	Entrance of Toxic Materials Into Body.....183
13.4.1.1	Inhalation.....185
13.4.1.2	Ingestion.....185
13.4.1.3	Skin Absorption.....185
13.4.2	Types of Toxic Materials.....185
13.5	Respiratory Hazards.....185
13.6	Hazards in Different Painting Operations....186
13.6.1	Surface Preparation.....186
13.6.1.1	Abrasive and Water Blasting.....186
13.6.1.2	Mechanical Cleaning.....186
13.6.1.3	Chemical Cleaning.....186
13.6.1.4	High Temperature Operations.....186
13.6.2	Painting Operations.....187
13.6.2.1	Storage of Paints.....187
13.6.2.2	Mixing and Applying Paints.....188
13.6.3	Work in High, Confined, and Remote Places...189
13.6.3.1	Work in High Places.....189
13.6.3.2	Confined Areas.....190
13.6.4	Remote Areas.....191
13.7	Personal Protective Equipment.....191
13.7.1	Clothing.....191
13.7.1	Gloves.....192
13.7.2	Protective Headwear.....192
13.7.2.1	Hard Hats.....192
13.7.2.2	Bump Hats.....193
13.7.2.3	Hair Covers.....193
13.7.3	Eye Protection.....193
13.7.3.1	Safety Glasses.....193
13.7.3.2	Safety Goggles.....193
13.7.3.3	Safety Shields.....193
13.7.4	Hearing Protection.....193
13.7.4.1	Ear Muffs.....194
13.7.4.2	Ear Plugs.....194
13.7.4.3	Canal Cups.....194
13.7.5	Safety Shoes.....194
13.7.6	Respirators/Ventilation.....194
13.8	Safety Program.....195

FIGURES

Figure 1 Schematic Drawing Illustrating Components
of Conventional Abrasive Blasting Equipment. 83

	<u>Page</u>
Figure 2	Schematic Drawing of Cross Section of Typical Water-Injected Wet Abrasive Blasting Nozzle..... 84
Figure 3	Cross-Sectional Drawing of Nozzles..... 86
Figure 4	Drawing Illustrating Effect of Shape of Abrasive Particle on Contour of Blast-Cleaned Metallic Substrate..... 88
Figure 5	Schematic Illustrating Typical Cleaning Angles for Various Surface Conditions..... 93
Figure 6	Illustration of Proper Stroke Pattern for Blast Cleaning..... 93
Figure 7	Illustration of Mixing and "Boxing" One-Component Paint: A - Pouring Off Pigment-Poor Vehicle, B and C - Mixing Pigment to Form Smooth Paste, D - Pouring in Vehicle and Mixing, E - Boxing Paint.....101
Figure 8	Illustration of Parts of Paint Brush.....107
Figure 9	Equipment Used in Applying Paint by Roller..108
Figure 10	Schematic Drawing Illustrating Basic Parts of Conventional Air Spray Application Equipment.....111
Figure 11	Drawing of Air-Spray Gun.....113
Figure 12	Cross-Sectional Drawing of Nozzle of Air-Spray Gun.....113
Figure 13	Illustration of Proper Spray Patterns.....114
Figure 14	Illustration of Improper Movement of Spray Gun When Applying Paint.....120
Figure 15	Illustration of Proper Procedure for Spray Painting Large Flat Surfaces..... 121
Figure 16	Schematic to Illustrate Proper Painting of Large Vertical Surfaces.....122
Figure 17	Illustration of Proper "Triggering" of Spray Guns.....123
Figure 18	Proper Spray Painting of Inside Corners.....124
Figure 19	Proper Spray Painting of Outside Corners.....125
Figure 20	Schematic Illustrating Importance of Spraying Surfaces With Protruding Parts From All Directions to Avoid "Shadowing Effect".....126
Figure 21	Sample Inspector's Contract Summary Form....144
Figure 22	Sample Daily Project Reports for Painting Inspectors.....145
Figure 23	Nomograph for Estimating Quantities of Paint Required for a Job.....148
Figure 24	Decision Tree 1: Support for Analysis of Coating Failures That Do Not Penetrate the Finish Coat.....174

	<u>Page</u>
Figure 25	Decision Tree 2: Support for Analysis of Coating Defects That Penetrate the Finish Coat.....175
Figure 26	Coating Condition and Identification Form..179

TABLES

Table 1	Compatibility of Commonly Used Paints.....	22
Table 2	Problems Encountered With Low VOC Coatings.	25
Table 3	TLV and Other Safety Data on Paint and Cleaning Solvents.....	27
Table 4	DOD and Military Component's Policy Documents on Lead-Based Paint.....	32
Table 5	Lead- and Chromate-Free Coating Specifications With VOC Limits.....	38
Table 6	Commonly Used Methods of Surface Preparation for Coatings.....	75
Table 7	SSPC and NACE Standards for Cleaned Steel Surfaces.....	80
Table 8	Procedures for Coating Removal.....	81
Table 9	Typical Physical Characteristics of Abrasives.....	89
Table 10	Approximate Rates of Paint Application.....	105
Table 11	Comparison of Conventional Air and Airless Spray.....	110
Table 12	Common Conventional Air-Spray Problems and Their Causes and Remedies.....	114
Table 13	Common Airless-Spray Problems and Their Causes and Remedies.....	116
Table 14	Spray Painting Errors.....	127
Table 15	Equipment for Inspecting Painting Operations.....	142
Table 16	Inspection Steps.....	143

REFERENCES	196
------------	-------	-----

GLOSSARY	184
----------	-------	-----

Section 1: INTRODUCTION

1.1 Purpose. This handbook presents information on the effective use of paint-type coatings to protect metal, concrete, and wooden structures at military activities from deterioration. In this handbook, the words "paint" and "coating" are used interchangeably. Sometimes, the word "paint" is used to describe an architectural rather than protective material, but this is not the case in this handbook.

1.2 Scope. This handbook covers virtually all aspects of coating fixed structures. These include surface preparation for painting; selection, application, and inspection of coatings for both original and maintenance painting; quality control methods and equipment; and painting different substrates and facilities. It does not cover painting of ships, aircraft, or motor vehicles. The coatings covered are limited to organic paint-type materials, with a few exceptions. Inorganic zinc, thermal spray metal, and powder coatings are included, because they are most commonly used as alternatives to conventional organic coatings and, like organic coatings, are usually applied by spray.

1.3 Deterioration of Facilities. The main purpose of painting military facilities is to protect them from deterioration. These structures comprise a vital resource in the defense of our nation. They must be kept in a state of operational readiness by efficient use of the limited funds available for this purpose. Unfortunately, these facilities are frequently subject to environments and uses that accelerate their natural deterioration and require costly repairs and maintenance. Metals corrode in aggressive soil, industrial or chemical atmospheres, or immersion environments; woods swell, warp, and crack during weathering; concrete and masonry structures crack and spall in severe environments; and organic polymeric materials suffer degradation in sunlight. To adequately meet the challenges of protecting constructed facilities, it is necessary to have a general understanding of the common ways in which materials deteriorate and the procedures used to control the deterioration.

1.3.1 Corrosion of Metals. Metals corrode because they exist in chemically unstable states. Thus, iron ore is a corrosion product in its natural, stable state. Energy must be used in blast furnaces to reduce iron to its metallic state. Iron and steel products are then slowly oxidized by corrosion to their previous stable lower energy states. Four conditions must be present for corrosion to occur:

- a) Anodic areas where corrosion occurs

- b) Cathodic areas where the metal is protected
- c) An electrolyte (conductive medium such as soil or water)
- d) A metallic path between the anode and cathode

In atmospheric corrosion, surface moisture and contamination serve as the electrolyte. Dissimilar metals are anodic and cathodic to each other; also, the same metal components have anodic and cathodic areas because of slight chemical or physical differences.

1.3.2 Deterioration of Wood. The chief causes of deterioration of wood are effects of ultraviolet light, and swelling and contracting. These adversely affect the physical properties of the wood.

1.3.3 Deterioration of Concrete. The chief cause of concrete deterioration is moisture and electrolyte penetration. This may result in deterioration of the concrete itself or in corrosion of reinforcing steel which causes spalling of the concrete.

1.3.4 Design Factors Affecting Deterioration. Poor design of structures may accelerate their deterioration or interfere with their protection by coatings. Examples of poor designs are listed below:

- a) Water traps
- b) Crevices
- c) Rough and sharp surfaces
- d) Limited access
- e) Incompatible environment
- f) Contact of dissimilar metals

1.3.4.1 Water Traps. Since water greatly accelerates deterioration, structures should be designed so that water is not collected. For example, angle irons and other configurations that can collect water should be oriented downward rather than upward. Weep holes of sufficient size should be placed where water collection cannot be otherwise avoided. Condensate water from air conditioners should not be allowed to run or drip on surfaces and steam or other vapors should not be allowed to impinge on surfaces.

1.3.4.2 Crevices. Crevices should be avoided in structures, because these oxygen-deficient areas accelerate metal corrosion. Thus, continuous welds should be used rather than skip welds. Back-to-back angles should also be avoided for this reason.

1.3.4.3 Rough and Sharp Surfaces. To obtain protection of a surface, a painter must be able to apply a uniformly thick, continuous film. Thus, irregular surfaces such as welds and other projections should be ground smooth to eliminate projections through the paint film. Weld-spatter, which is loosely-bonded to the steel, must be removed for two reasons. First, it creates crevices which lead to crevice corrosion and, second, as the mill scale becomes disbonded, the barrier film will be broken.

Sharp edges should be rounded (1/8 inch or more radius is ideal) because a uniformly thick coating cannot be applied over the edge. This is because wet coatings draw thin on them. Sharp interior corners should be avoided, since they may receive an excessive coating thickness.

1.3.4.4 Limited Access to Work. Areas to be protected should be readily accessible for inspection and maintenance. Difficult-to-reach areas are not only difficult to prepare and coat, but reaching them may also constitute a safety hazard.

1.3.4.5 Incompatible Environment. Materials must be compatible with the environment in which they are located. Thus, aluminum should not come into direct contact with concrete, because the alkalinity of the concrete will attack the aluminum.

1.3.4.6 Contact of Dissimilar Metals. Dissimilar metals probably present the biggest design problem. Because they have different corrosion potentials, they may corrode rapidly when in contact with each other. Examples of dissimilar metal (galvanic) corrosion are:

- a) Steel pipe passing through an aluminum deck
- b) Steel nut on a copper valve
- c) Aluminum stanchion with a bronze lifeline
- d) Aluminum plate with steel or different alloy aluminum rivets
- e) Mild steel attached to stainless steel

Dissimilar surface conditions (e.g., threads, scratches, etc.) may also cause galvanic corrosion.

1.4 Control of Facilities Deterioration. While coating of surfaces is the most commonly used method of protecting them, it can be used most effectively in conjunction with other control methods. These include but are not limited to proper design of components, proper selection of materials and components, cathodic protection, controlling the environment, and use of corrosion inhibitors.

1.4.1 Corrosion Control by Coatings. Coatings protect metals from corrosion by interfering with one or more of the conditions necessary for corrosion to occur. The three protective mechanisms of coatings are:

- a) Barrier
- b) Inhibitors
- c) Cathodic protection

Regardless of the mechanism(s) of protection imparted by coatings, a multiple coat system is normally recommended for maximum protection of metals. The primer is formulated to bond well to the substrate and provide a good surface for adhesion of additional coats. Zinc or inhibitive primer pigments can provide corrosion control, as described above. Intermediate coats provide additional barrier protection and unite the primer and finish coats. The finish coat provides additional barrier protection as well as resistance to weathering, and color, texture, and gloss.

1.4.1.1 Barrier Protection. Most coatings provide corrosion protection by forming a barrier that is relatively impermeable to moisture and electrolytes (usually salts) necessary for corrosion. No organic coating is completely impermeable, but some are much more so than others. Obviously, the coating film must be thick enough and free of discontinuities (holidays) to achieve maximum barrier protection.

1.4.1.2 Inhibitive Pigments. Some pigments are used in primers for metals to inhibit the corrosion reaction at the metal/primer interface. Red lead and zinc chromate pigments, used for this purpose for many years, are seldom used today because of health and environmental concerns. Acceptable alternate corrosion control pigments are available.

1.4.1.3 Cathodic Protection. Some coatings have a high loading of fine zinc particles to provide cathodic protection to steel surfaces. They convert anodic areas on the steel to cathodic areas. The zinc particles must be in electrical contact with

each other and with the steel to provide this protection. The two basic types of zinc-rich coatings, organic and inorganic zinc, will be described later in this handbook.

A film of inorganic zinc silicate coating is unique because the film is relatively porous. Initially, the coating protects steel by cathodic protection, but its corrosion products gradually fill the porosity, so that it becomes a barrier coating. Should this barrier coat become scratched to expose the steel substrate, cathodic protection will begin again until the damage is healed. An inorganic zinc silicate coating is also unique in that it reacts with the steel to form a chemical bond. Many organic coatings rely on physical rather than chemical bonding to steel.

1.5 Painting for Purposes Other Than Protection.

Facilities are often painted for other purposes than, or in addition to, protection. These include appearance, marking, and safety.

1.5.1 Cosmetic Appearance. Painting is an important factor in promoting morale and productivity. NAVFAC P-309, Colors for Navy Shore Facilities, and Army TM5-807-7, Color for Buildings, present scientific approaches to the use of color to improve working and living environments.

FED-STD-595, Colors Used in Government Procurement, presents standard colors currently used by the Government. The colors are identified by five-digit numbers, and defined by fundamental color data. The standard, also available as a fandeck, includes reference chips of each color.

1.5.2 Marking Paints. Marking paints are used on airfield runways, streets, and parking lots. Their chief function is to provide safety for personnel and equipment.

1.5.3 Safety Colors and Designs. Safety colors and designs are used on military installations for rapid identification of hazards or safety equipment. They are also described in NAVFAC P-309.

1.5.4 Reflective Finishes. Reflective finishes on concrete floors of hangars and shops may increase the lighting for workmen, particularly in sheltered areas such as under the wings of aircraft. Such smooth floors are easier to keep clean.

1.5.5 Nonskid Surfaces. Nonskid surfaces are frequently made by adding grit to coatings on floors, ramps, and other walking surfaces to provide slip resistance.

1.5.6 Antifouling Coatings. Antifouling coatings prevent the attachment and growth of marine fouling organisms by the controlled release of toxic materials.

Section 2: COATING COMPOSITIONS AND CURING MECHANISMS

2.1 Coating Composition. The primary ingredients used to formulate coatings can be placed into one of three basic categories - solvent, resin, and pigment. Each of these categories has a special function in the formulation of coatings. The resin (also called binder) and the solvent comprise the liquid portion, sometimes called the vehicle. Since the solvent evaporates as a coating cures, it is sometimes called the volatile vehicle, and the resin the nonvolatile vehicle. The resin and pigment which comprise the solid film after evaporation of the solvent are sometimes called the total solids or film solids.

Historically, the first paints utilized fish or vegetable (e.g., linseed) oils as binders and natural earth pigments. The first solvents were from trees (e.g., turpentine). Now most resins and solvents are derived from petroleum, and many pigments are derived from organic synthesis or modification of natural minerals.

2.1.1 Solvent. Organic solvents are used to dissolve the resin material and reduce the viscosity of the product to permit easier application. They also control leveling, drying, durability, and adhesion. Because the different organic polymers in different formulations vary greatly in their solubilities, some resins require much stronger solvents and/or greater amounts than others to dissolve them. In most water-based coatings, the water is a dispersing rather than a dissolving agent.

A blend of solvents is generally used in paint to achieve all the properties desired from them. The blend must completely dissolve the total binder system and be balanced to ensure compatibility and stability during all stages of curing. Improper blends may result in cloudy films, pigment float to the wet film surface, or reduced film durability.

Paint solvents evaporate into the air and contribute to the production of photochemical smog. Thus, there is a great pressure to reformulate coatings to reduce the solvent content of paints.

2.1.2 Resin. Resins, also called binders, are the film-forming portions of coatings. They are usually high molecular weight solid polymers (large molecules with repeating units) in the cured film. In some cases, lower molecular weight units in two liquid components react with each other upon mixing to polymerize into the higher molecular weight solid.

The resin is responsible for many of the properties of the coating. Thus, coatings are usually identified generically by the types of their resins. Important film properties related to the resin chemistry are:

- a) Mechanism and time of curing
- b) Performance in different environments
- c) Performance on different substrates
- d) Compatibility with other coatings
- e) Flexibility and toughness
- f) Weather resistance
- g) Adhesion
- h) Ease of topcoating and repair
- i) Application properties (wetting, build, pot life, etc.)

2.1.3 Pigment. The pigment constitutes the solid portion of a wet paint. Pigments are insoluble in the vehicle and are generally heavier than the liquid vehicle portion. They may settle to the bottom of a container upon prolonged standing. Natural earth pigments are generally much more stable to light than synthetic organic pigments.

a) The pigment portion of coatings contributes to the following desirable properties:

- (1) Opacity (hiding)
- (2) Color
- (3) Corrosion inhibition
- (4) Weather resistance
- (5) Moisture resistance
- (6) Level of gloss and hardness
- (7) Film build and reinforcement

b) The chief function of the pigment is to provide opacity (hiding) to obscure the substrate and protect the organic resin from degradation by the sun's ultraviolet light. Organic resins degrade to some extent in sunlight, some much more than others. Titanium dioxide is the pigment most frequently used to impart opacity to white paints and light tints, because it has high opacity. If a coat of paint does not completely obscure a surface, it is usually necessary to apply an additional coat.

c) Another important function of some pigments has already been mentioned - corrosion control. Inhibitive pigments can be very effective in reducing the corrosion that would otherwise occur. Lead and chromate inhibitive pigments were commonly used in paints in the past but are now restricted because of adverse health effects. Examples of lead- and chromate-containing pigments, and of those presently used, environmentally acceptable corrosion-inhibitive pigments are listed below:

Common Inhibitive Pigments

Relatively Hazardous

Red Lead
White Lead
Zinc Chromate
Strontium Chromate
Basic Lead-Silico-Chromate

Relatively Nonhazardous

Zinc Oxide
Zinc Phosphate
Zinc Molybdate
Calcium Borosilicate
Calcium Phosphosilicate
Zinc Phosphosilicate
Barium Metaborate

d) Pigments also may improve adhesion and decrease moisture permeability. Leafing pigments such as aluminum tend to align themselves as parallel plates in the film to effectively increase film thickness by increasing the path that moisture must take to reach the substrate.

e) Other things being equal, the greater the resin-to-pigment ratio, the glossier will be the coating. The size of pigment particles (fineness of dispersion or grind) of the pigment in the vehicle also affects gloss. Other things being equal, the finer the dispersion, the glossier the cured film. Secondary or filler pigments (talc, silica, etc.) are used to control viscosity, wet film build and leveling, and settling. These cheaper pigments provide very little hiding. The pigment to resin ratio, generally expressed as pigment volume concentration (PVC), can vary widely. There can be no pigment, or the pigment content can approach a value called the critical pigment volume concentration (CPVC). As this point is approached, there is insufficient binder to wet the individual

pigment particles and bond them to the substrate. This may result in a poorly bonded or porous film or one with a mottled appearance.

2.1.4 Other Components. There are also many additives used in small amounts in coatings to provide some special function. These include antifoam agents, flattening agents to reduce gloss, mildewcides, adhesion promoters, viscosity modifiers, and ultraviolet stabilizers.

2.1.5 Spreading Rate. If the percent solids by volume of a coating is known, the dry film thickness of a coating can be determined from its wet film thickness by the relationship:

$$\text{Dry Film Thickness} = \frac{\text{Wet Film Thickness} \times \text{Percent Solids by Volume}}{100}$$

Also, it can be shown mathematically that if 1 gallon of coating is uniformly applied to a flat surface at 1 mil (0.001 inch) wet film thickness, it will cover an area of 1600 square feet. Thus, if the percent solids by volume of a paint is provided by the supplier, its spreading rate at any dry film thickness (dft) can be determined, as shown below:

- | | | | | | |
|----|----------------------|---|------------------|----|-----------|
| a) | 0 Percent Solvent | - | 1600 square feet | at | 1-mil dft |
| | (100 Percent Solids) | | 800 square feet | at | 2-mil dft |
| | | | 400 square feet | at | 4-mil dft |
| b) | 50 Percent Solvent | - | 600 square feet | at | 1-mil dft |
| | (50 Percent Solids) | | 400 square feet | at | 2-mil dft |
| | by volume | | 200 square feet | at | 4-mil dft |

Obviously, this relationship is only true for coatings as received from the supplier without thinning. Thinning will reduce the percent solids by volume reported by the supplier and require calculating a new value before the above relationship can be used.

2.2 Mechanisms of Curing of Coatings. Coatings cure from one of three basic ways:

- a) Air oxidation (polymerization) of unsaturated drying oils
- b) Evaporation of solvent from lacquers or water from emulsions
- c) Chemical reaction of components or chemical reaction with water in air

Coatings that cure by solvent or water evaporation are unchanged chemically during curing. They are said to be thermoplastic, because they can be softened by heat or by solvent. Chemically curing coatings are said to be thermosetting, because they are not softened by heating or by solvent. Air-oxidizing coatings (oil-based paints) are thermoplastic after initial curing. Upon further curing (e.g., 6 months or more), the additional polymerization (cross-linking of polymers) slowly converts them to thermosetting coatings. This is shown below:

Thermoplastic Coatings

Lacquers
 Latex Products
 Oil-Based Products (Initially)

Thermosetting

Chemically Reacting Products
 Oil-Based Products (After Aging)

2.2.1 Air Oxidation of Drying Oils. For coatings that cure by air oxidation of drying oils (usually vegetable), oxygen from the air reacts with unsaturated fatty acids in their drying oils. By this reaction, liquid resins are converted to solid films. Metal driers are usually incorporated into formulations of drying oil coatings to accelerate their normally slow curing.

a) Examples of coatings that are cured by this mechanism are:

- (1) Unmodified drying oils
- (2) Alkyds
- (3) Silicone alkyds
- (4) Epoxy esters
- (5) Oleoresinous phenolics

b) Such coatings wet surfaces very well and generally perform well in mild atmospheric environments, but they have limited durability in chemical environments, particularly alkaline environments. Epoxy esters provide some additional chemical resistance. They should not be confused with higher performance, two-component, chemically reacting epoxies. Oleoresinous phenolic coatings are the only oil-based coatings that can be used successfully in water immersion service.

c) Formulating oil-based coatings with low-solvent content presents difficulties and requires major formulation changes from those used for high-solvent coatings. Thus, attempts are also being made to develop waterborne alkyd products.

2.2.2 Solvent of Water Evaporation. Coatings that cure by simple evaporation of organic solvent are sometimes called lacquers. They are made by dissolving solid resins in an appropriate solvent. After application of a lacquer, the solvent evaporates to deposit the resin in a thin film. No chemical change occurs in the resin.

a) Examples of coatings that cure by this mechanism are:

- (1) Shellacs
- (2) Vinyls (polyvinyl chlorides)
- (3) Chlorinated rubber
- (4) Acrylics
- (5) Bituminous coatings (coal tars and asphaltics)

b) Coatings of this type have poor solvent resistance, since they are deposited from a solvent, but are easy to topcoat and repair because the topcoat solvent bites into the undercoat to bond tightly. Because lacquers are high in solvent content, that is, volatile organic compounds (VOC), their use has been greatly curtailed.

c) Latex and many other waterborne coatings also cure by simple water evaporation. Emulsified particles of solid resin coalesce to form a film as the water is lost. These coatings usually contain some organic solvent to control curing and improve application properties. Latex films are quite flexible and tend to be more permeable than oil and alkyd films. Examples of latex coatings are:

- (1) Acrylics
- (2) Vinyls (polyvinyl acetates)

d) At this time, it is important to point out that there are other types of waterborne coatings that cure by mechanisms other than simple water evaporation. The three basic types of waterborne coatings are:

- (1) Water soluble (of limited value)
- (2) Water reducible
- (3) Emulsions

e) Water soluble coatings are not durable enough for general use. The other two types of waterborne coatings find use on military facilities, although they may be somewhat less durable in some environments than corresponding solvent-based types. Water-reducible coatings contain a solvent blend that can be thinned with water. Alkyd and epoxy formulations are available in either water-reducible or emulsion forms. Such alkyd films are cured by air oxidation, and two-component epoxy films by chemical reaction.

2.2.3 Chemical Reaction. Coatings that cure by chemical reaction are usually the most durable. They are generally packaged in two separate containers that are mixed to initiate the reaction. Components must be combined in the specified proportions in the manner specified by the supplier to achieve a film with optimum properties. Sometimes, an "induction period" is required after mixing and before application to permit the reaction to get started. After mixing, there is always a "pot life" during which the coating must be applied, before the reaction has advanced so far that the coating cannot be properly applied.

a) Examples of coatings that cure by chemical reaction are:

- (1) Epoxies
- (2) Coal tar epoxies
- (3) Polyurethanes
- (4) Polyesters

b) Because these coatings are thermosetting, they have excellent chemical and solvent resistance. They are difficult to topcoat when fully cured, because topcoat solvent cannot bite into the films. Thus, a topcoat is best applied while the undercoat still has some residual tack. If a completely cured thermosetting coating is to be topcoated, it is necessary to first spray a thin (e.g., 2 mil wet film thickness) tie coat (tack coat) of the topcoat and allow it to cure to a tacky state.

c) Another example of a chemically curing coating is an inorganic zinc coating. Different formulations may cure by different types of reaction. Usually the cure reaction involves the hydrolysis (reaction with water vapor from the atmosphere) of the silicate binder. Some cure by reaction with water from the air, and thus cure slowly in dry environments. A one-package water-based inorganic zinc coating cures by chemical reaction after evaporation of the water.

d) Zinc-rich organic coatings, on the other hand, cure by the mechanism of curing of their organic binders. Thus, zinc-rich epoxies cure by chemical reaction and zinc-rich vinyls, by solvent evaporation.

2.3 Properties of Different Generic Types of Coatings. The properties of coatings commonly used on military facilities will be discussed individually below and then their properties will be summarized in a series of tables. Special mention will be made of the ease of formulating each generic type with a low VOC (solvent) content, since new restrictions on VOC content may limit or eliminate their use.

2.3.1 Alkyds and Other Oil-Containing Coatings. The unmodified drying oil coatings initially developed were very easily applied, did not require a high level of surface preparation, and had good flexibility; they could readily expand and contract with the substrate. They did, however, have several drawbacks: they were slow to dry, had residual tack, and provided a limited period of protection. They cannot be used in sea water immersion service or on alkaline substrates (e.g., concrete), because they are easily hydrolyzed (deteriorated by reaction with water) by alkalinity. They are used most on wood and steel surfaces.

a) Alkyd coatings, prepared by chemically modifying drying oil formulations, cured much faster than the unmodified ones and did not have residual tack. They retained the good application properties, but lost some flexibility. Silicone alkyds were developed by incorporating silicone into the resin to provide greater gloss retention. Epoxy esters were another modification of drying oils that improved some performance properties, particularly their chemical resistance, but worsened others, such as gloss retention. Still, none of these were suitable for a severe environment such as sea water. Oleoresinous phenolic drying oil formulations could be successfully used in water immersion.

b) Air-oxidizing coatings have limited solvent resistance. They continue to oxidize and cross-link after initial drying and curing. Thus, with time, they become harder, more brittle, and less soluble in solvent. That is, they become more like thermosetting coatings and are harder to recoat and maintain.

c) Although alkyds have long been the most widely used type of protective coating, their use is dropping rapidly because of difficulties in preparing formulations with: low VOC content, a brushable viscosity, and good film properties. Exempted halogenated hydrocarbons are presently being used to produce limited low-VOC alkyd formulations, but this exemption is expected to be withdrawn in the near future.

Alkyd and Most Other Air-Oxidizing Coatings

<u>Advantages</u>	<u>Limitations</u>
Easy to apply/repair/topcoat	Relatively high in VOCs
Good initial flexibility possible	Poor performance in severe environment
Good surface wetting/adhesion	Poor chemical/solvent resistance
Good gloss retention	Poor immersion resistance
Relatively inexpensive	Poor alkali resistance
Based on renewable source	Poor heat resistance
	Become brittle with extended aging

2.3.2 Water Emulsion (Latex) Coatings. Water emulsion coatings, commonly called latex coatings, have been successfully used for many years to coat wood and masonry structures. The porous nature of their films allows water vapor to pass through them, i.e., they are breathing. This porosity reduces their durability on steel. Thus, much effort is being made to develop more durable products because of the great advantages of their low VOC contents and ease of application and clean-up. In addition, water-emulsion coatings have excellent flexibility and low cost, and are easily topcoated and repaired. Drawbacks include poor solvent and heat resistance (as with all thermoplastics), poor immersion resistance, and difficulty in bonding to smooth oil/alkyd coatings and chalky surfaces. The poor bonding is due to insufficient content of organic solvents to soften and wet the binder in the existing paint film. Because of this limited adhesion, it is necessary to sand smooth enamels and/or use a surface conditioner before topcoating with latex

coatings. Also, latex paints do not cure well at temperatures below 50 degrees F, as the emulsion does not coalesce to form a good film.

Water Emulsion (Latex) Coatings

<u>Advantages</u>	<u>Limitations</u>
Environmental acceptability	Limited durability
Easy to apply/repair/topcoat	Poor chemical/solvent resistance
Excellent flexibility and color and gloss retention	Poor wetting of surfaces
Low cost	Poor immersion service
Available in wide range of color and gloss	Must cure above 50 degrees F

2.3.3 Lacquers. Lacquers (e.g., vinyls, chlorinated rubbers, and acrylics) form durable films that have good water and chemical resistance but, being thermoplastics, poor solvent and heat resistance. They have a low film build but dry so fast that they can be quickly topcoated. When used on steel, they require a blast-cleaned surface, and in some cases wash priming, for good adhesion. They are easy to topcoat and repair and can be formulated for good gloss retention. The good weathering of acrylic lacquers is duplicated in acrylic water emulsion coatings.

a) The chief disadvantage of lacquers is their high VOC content. Because of their uniquely excellent performance on exterior concrete swimming pools, chlorinated rubber coatings have been granted temporary exemptions in some localities for this use despite their high VOCs.

Lacquers (Vinyls, Chlorinated Rubbers, and Acrylics)

<u>Advantages</u>	<u>Limitations</u>
Rapid drying and recoating	High in VOCs
Good chemical resistance	Poor solvent/heat resistance
Good in water immersion	Low film build
Good gloss retention possible	Blasted surface necessary
Good durability	Occasional poor adhesion
Easy to topcoat and repair	
Can be applied at low temperatures	

b) Bituminous (asphalt and coal tar) coatings are also lacquers, but they are discussed separately because of their unique film properties. Bituminous coatings have found much use

in the past because they were inexpensive and easy to use. They have good water resistance but weather poorly in sunlight. They are used much less now because of toxicity concerns and their limited durability.

Bituminous Coatings

Advantages

Low cost
Easy to apply/repair/topcoat
Good water resistance
Good film build
Low level of surface preparation

Limitations

High in VOCs
Poor solvent/heat resistance
Poor weathering
Black color only

2.3.4 Epoxy Coatings. Epoxy coatings are two-component thermosetting products. (Epoxy-ester coatings are modified oil coatings, refer to par. 2.3.1.) One part is commonly called the base and the other, the catalyst component, although they are both best described as coreactants. Epoxies are available in a variety of formulations. Those most commonly used in general service are the epoxy polyamide (which has better water resistance) and the amine-cured epoxy (which has better chemical resistance). Epoxies and polyurethanes provide the best overall combinations of film properties of any organic coatings.

a) Epoxy films are tough and relatively inflexible. Thus, they cannot expand or contract much without cracking. However, they bond well and are very durable in most environments. They require a blasted steel surface, and they chalk freely in sunlight. An aliphatic polyurethane finish coat is usually applied when the coating is exposed to sunlight. Epoxies can be formulated to be low in VOCs, some actually solvent-free.

b) Epoxies, as do all thermosetting coatings, have topcoating problems. Solvent from a topcoat cannot penetrate a fully cured epoxy to bond tightly to it. Thus, a topcoat of a multiple coat system is applied when the undercoat is still somewhat tacky (e.g., within 4 days). If this is not possible, a fog coat (thin coat of about 2 mils wet film thickness) is first applied by spray and allowed to cure to a tacky state (e.g., 4 hours) before a full coat is applied.

Epoxy CoatingsAdvantages

Low in VOCs
 Good solvent/water resistance
 Tough, hard, smooth film
 Good adhesion
 Good abrasion resistance

Limitations

Limited pot life
 Chalk in sunlight
 Cure best above 50 degrees F
 Topcoating is a problem
 Blasted surface needed

2.3.5 Coal-Tar Epoxy Coatings. Coal-tar epoxy coatings are basically epoxies (with all properties of epoxies) to which coal tar has been incorporated. The coal tar reduces cost, improves water resistance, and provides for greater film builds. Because of the coal tar, coatings tend to become brittle in sunlight, and there is great concern about toxic effects of the coal tar. They are used primarily on steel piling and other buried structures. The catalyst component is usually either a polyamide or an amine.

Coal-Tar Epoxy CoatingsAdvantages

Low in VOCs
 Good water/chemical resistance
 Good film build
 Good abrasion resistance

Limitations

Toxic; personal protection needed
 Limited pot life
 Blasted surface needed
 Topcoating is a problem
 Available only in black, dark red, or aluminum

2.3.6 Polyurethane Coatings. Polyurethane coatings are one- or two-package systems. For two-package systems, one component is an isocyanate and the other a polyol component. Because of the reactivity of the isocyanate, polyurethanes are moisture sensitive, and the gloss may drop when the wet film is exposed to high humidity. One component types cure with moisture supplied from the atmosphere. The toxicity of the isocyanate component is of great concern, and personal protection, including respirators, must be used when applying them. They require skilled applicators. Polyurethane coatings are available in a variety of formulations, giving rise to a variety of properties (e.g., may be tough or elastomeric). They perform well in most environments. Aliphatic polyurethanes have excellent weathering in sunlight; aromatic polyurethanes do not, but they have better chemical resistance. Both types can readily be formulated to be low in VOCs.

Polyurethane CoatingsAdvantages

Low in VOCs
 Good solvent resistance
 Good hardness or flexibility
 May have excellent gloss
 Good durability
 Good abrasion resistance

Limitations

Highly toxic; need personal protection
 Moisture sensitive; gloss may drop
 Skilled applicator needed
 Limited pot life
 Blasted surface required
 High cost

2.3.7 Polyester Coating. Polyester coatings are used most with fiberglass or glass flake reinforcement. They can be very tough and durable but are seldom used today on military facilities except with glass reinforcement.

2.3.8 Inorganic Zinc Coatings. Inorganic zinc coatings usually have a silicate resin and may cure by several different mechanisms. They can be formulated to be acceptably low in VOCs, particularly the water-based products. The silicate film is very hard and abrasion resistant. When applied too thickly, they may mud crack. Thus, they are generally applied at less than 5 mils dft, although some products can successfully be applied at greater thicknesses. They provide cathodic protection to steel, but as the zinc corrosion products fill the natural film porosity, they begin to provide barrier protection. If this barrier is broken by impact, cathodic protection will again take over until the break is healed by again filling with zinc corrosion products. They require greater steel surface cleanliness than do other coating types. They must be applied by a skilled applicator using a constantly agitated pot to keep the heavy zinc particles suspended. Inorganic zinc silicate coatings frequently do not bond well to each other, and it is safest to repair them using a zinc-rich organic coating. Problems may occur when topcoating them with organic coatings. Small bubbles of air or solvent vapors escaping from the porous silicate film may create holidays. Because of this concern, and their good performances without topcoating in a variety of services, it is often best not to topcoat them.

Zinc-rich organic coatings require less surface preparation and are easier to topcoat than inorganic zinc products. However, if properly applied, inorganic zinc coatings are extremely durable in an atmospheric environment, the steel preferentially receiving cathodic protection from the zinc. The zinc is attacked, however, by acid and alkali (i.e., is

amphoteric). Inorganic zinc coatings have not been used often in continuous water immersion because of concern for their limited period of protection.

Inorganic Zinc Coatings

Advantages

Can be low in VOCs
Excellent abrasion resistance
Excellent heat resistance
Good atmospheric durability
Useful as shop primer
Costly

Limitations

Needs clean, blasted surface
Requires skilled applicator
Constant agitation needed
Difficult to topcoat
Attacked by acid and alkali

2.3.9 Zinc-Rich Organic Coatings. Zinc-rich organic coatings utilize an organic resin rather than an inorganic silicate binder. Zinc-rich organic coating films can be of the thermoplastic (e.g., utilize vinyl or chlorinated rubber resins) or the thermosetting type (e.g., utilize epoxy or polyurethane resins). Film properties of zinc-rich organic coatings are similar in most respects to those of zinc-free organic coatings using the same resin. Organic zinc-rich coatings do not require as high a level of blast-cleaned steel surface as do zinc-rich inorganic coatings, and they are easier to topcoat.

Zinc-Rich Organic Coatings

Advantages

Can be low in VOCs
Good durability
Relatively easily topcoated
Moderate surface preparation needed

Limitations

requires skilled operator
Constant agitation necessary
Unsuitable for acid or alkali
Costly

2.4 Coating Compatibility. Because of their different chemical and physical properties, coatings of different generic types or with different curing mechanisms are generally incompatible with each other. Those of the same generic type or with similar curing mechanisms are generally compatible with each other. Table 1 lists compatibilities and incompatibilities of different generic types of coating.

Another way to check solvent compatibility is to determine its solvent solubility. To do this, soak a cloth in methylethyl ketone or acetone, rub it against the existing paint, and visually check for pickup of paint. The paint is classified as "solvent soluble," if paint is picked up and as "solvent

insoluble," if not. Solvent soluble coatings are generally not compatible with coatings having strong solvents such as epoxies and polyurethanes.

A more system-specific way to determine compatibility of a new coating with an existing one is to apply a small patch of the new paint over the old one. If any of the incompatibilities described below exist, it will become visually apparent on the patch within a few days. Incompatibilities associated with differing mechanical properties (e.g., a more rigid coating over a more flexible one) or sensitivity to alkaline conditions occur in a longer timeframe and are also discussed below.

2.4.1 Bleeding. Bleeding (staining) may occur when a coating with a solvent is applied over an existing bituminous (coal tar or asphalt) paint or pavement. The solvent dissolves the bituminous material and permits it to spread through the topcoat to cause a brown surface discoloration. This normally does not adversely affect the film properties but produces an unsightly appearance.

2.4.2 Disbonding of Old Paint. Strong solvents in a topcoat may penetrate the existing undercoat and reduce its adhesion to the substrate. This may then result in disbonding of the total coating system from the substrate.

2.4.3 Topcoat Checking. An incompatibility may occur when a relatively rigid topcoat is applied over an existing flexible coating. If the topcoat checks (cracks in the topcoat only) to relieve the stress.

2.4.4 Poor Adhesion of Latex Topcoats to Enamels. Problems are frequently encountered in obtaining good bonding of latex topcoats to chalky surfaces or smooth fully-cured alkyd enamels. There is usually insufficient organic solvent in the latex topcoat to dissolve sufficient enamel to bond tightly to it. It may be necessary to first lightly sand the enamel to provide more texture for adhesion and/or apply an oil-based primer as a tack coat, before applying the latex topcoat.

2.4.5 Oil-Based Paints Applied to Alkaline Surfaces. Moist alkaline conditions cause a slow breakdown of oil-based paint films. The chemical reaction is called hydrolysis or saponification. The rate at which this occurs and the resulting rate of coating deterioration depend upon the environmental conditions and the specific formulation of the materials. However, in time oil-based coatings applied to alkaline surfaces will delaminate and peel.

Table 1
Compatibility of Commonly Used Paints
(Primer or existing coating less than 6 months old.)

Primer or Existing Coating	Topcoat										
	Oil Drying			Latex		Solvent Drying		Chemically Reacting			
	Oleoresinous	Silicone Alkyd	Alkyd	Acrylic	Polyvinyl Acetate	Vinyl	Chlorinated Rubber	Epoxy	Coal Tar Epoxy	Urethane	Polyester
Oil Drying											
Oleoresinous	C	C	C	CT	CT	NR	NR	NR	NR	NR	NR
Alkyd	C	C	C	CT	CT	NR	NR	NR	NR	NR	NR
Silicone Alkyd	C	C	C	CT	CT	NR	NR	NR	NR	NR	NR
Latex											
Acrylic	C	C	C	CT	CT	C	C	NR	NR	NR	NR
Polyvinyl Acetate	C	C	C	CT	CT	C	C	NR	NR	NR	NR
Solvent Drying											
Vinyl	C	C	C	CT	CT	C	C	NR	NR	NR	NR
Chlorinated Rubber	C	C	C	CT	CT	NR	C	NR	NR	NR	NR
Bituminous	NR	NR	NR	CT	CT	NR	NR	NR	NR	NR	NR
Chemically Reacting											
Epoxy	NR	NR	NR	NR	NR	CT	NR	CT	CT	CT	CT
Coal Tar Epoxy	NR	NR	NR	NR	NR	NR	NR	CT	CT	NR	NR
Zinc Rich Epoxy	NR	NR	NR	NR	NR	CT	CT	CT	NR	P	NR
Urethane	NR	NR	NR	NR	NR	NR	NR	NR	NR	CT	C
Polyester	NR	NR	NR	NR	NR	NR	NR	CT	NR	CT	CT
Inorganic Zinc	NR	NR	NR	CT	NR	CT	NR	CT	CT	P	NR

C = Normally Compatible.

CT = Compatible when special preparation and/or application conditions are met.

NR = Not recommended because of known or suspected problems.

P = A urethane may be used as a topcoat if its coreactant is polyether or acrylic, but not if it is polyester.

Section 3: ENVIRONMENTAL, OCCUPATIONAL, AND SAFETY ISSUES

3.1 Introduction. Environmental and health concerns have led to increased restrictions on coating operations. Material composition, surface preparation procedures, and application techniques have been affected. This chapter summarizes these restrictions and concerns. Detailed information on specific regulations related to these issues can be obtained from installation offices responsible for environmental, occupational, and safety issues.

3.2 Material Composition Issues

3.2.1 VOC Restrictions. VOCs make up the solvent portion of coatings. When emitted into the atmosphere, they may combine with oxides of nitrogen to form ozone, a major component of smog. The Clean Air Act of 1970 (amended in 1977 and 1990) requires states to develop and implement plans to ensure that the Environmental Protection Agency's (EPA) National Ozone Standard (less than 0.12 parts ozone/million parts air (ppm), by volume) is met (National Ambient Air Quality Standard, 40 Code of Federal Regulations (CFR) 50). To help meet this requirement, some states and regions have placed limits on the VOC content of paints and coatings.

3.2.1.1 Definition of VOC. For paints and coatings, VOC is defined as the amount of volatile organic material measured in a specific test procedure. The test procedure used in most regions is EPA Method 24 (40 CFR 60, Appendix A). The VOC content that is measured following such a procedure may be different from that calculated based upon the coating formulation. For field applied coatings, the VOC is determined on the coating as it is applied. That is, if the coating was thinned for application, the thinner contributes to the VOC level.

3.2.1.2 Types of Regulations. VOC regulations may place a limit on the VOC content of liquid coatings or the amount of VOC that a coating shop can release into the atmosphere, or may require a minimum transfer efficiency, depending upon the local regulations. VOC-content regulations vary from region to region within states and between states, depending upon the ability of a region or state to maintain compliance with the National Ambient Air Quality Standard for ozone. VOC-content regulations may apply to either or both shop-applied coatings and field-applied coatings (architectural). Many regions of the country have restrictions on shop-applied coatings, but only a few have restrictions on architectural coatings. (However, a national rule for architectural coatings is expected to become effective in 1996.) For military facilities, rules affecting shop-applied coatings (e.g., the miscellaneous metal parts rule) are of

greatest concern to the facility. The VOC limit for miscellaneous metal parts is 340 grams per liter (g/L) in most parts of the country. This limit is the result of a 1978 Federal EPA guideline for shop-applied coatings for metals (commonly called miscellaneous metal parts) which 35 states adopted as part of their state implementation plans for VOC control. Regulations that limit the total amount of organic materials released into the air by a coatings shop are also in effect in some areas of the country. Architectural coatings are regulated in California and some other regions of the country. In California, the acceptable limits are based on the type of structure to be coated (e.g., residential versus industrial) and coating type. For example, for most coatings for residential use, the limit is 250 g/L and for steel in corrosive environments, the limit is usually 420 g/L. Some special use coatings have higher or unrestricted VOC limits. Since these regulations are subject to change and since they vary from region to region, a general listing of which paints comply with local regulations is not presented.

3.2.1.3 Effect on Coatings. Traditional solvent-borne coatings, such as alkyds and epoxies, have been reformulated to meet the VOC regulations by using binders with lower viscosities, modifying the solvents or using other techniques to lower the VOC content. As examples, an epoxy, MIL-P-24441 has been reformulated to have a VOC content less than 350 g/L. New lower VOC content coating types have also been developed by using other coating technologies such as waterborne or powder. VOC-induced trends in coating selection are summarized below:

- a) Greater use of water-based paints
- b) Greater use of high-solids paints
- c) Less use of oil-based paints
- d) Elimination of lacquers (vinyls and chlorinated rubbers)
- e) Increased use of powder coatings

In general, to obtain an acceptable service life, a cleaner, better prepared surface is required for low-VOC content coatings than for traditional higher VOC content coatings. Application of low-VOC content field-applied coatings may also be more difficult than higher VOC content coatings.

Problems have been encountered with the use of some low-VOC content paints. They are summarized in Table 2.

Table 2
Problems Encountered With Low-VOC Coatings

Generic Coating Type	Problems Observed
Oil-based	Longer drying time Residual tack or softness Poor leveling Wrinkling
Two-component epoxies	Reduced pot life Shortened drying time Settling Sagging Poor application properties
Polyurethanes	Reduced pot life Inability to apply thin films Reduced gloss

3.2.2 Application Issues. In some regions of the country, VOC emissions into the air have been further reduced by regulations restricting the methods of application of coatings to those with a minimum transfer efficiency of 65 percent. Transfer efficiency is defined as the percent of the mass or volume of solid coating that is actually deposited on the item being coated, as shown in the following formulas:

$$\begin{aligned} \text{Transfer Efficiency} \\ \text{(Percent)} &= \frac{\text{Mass of Solid Coating on Item} \times 100}{\text{Mass of Solid Coating Consumed}} \end{aligned}$$

$$\begin{aligned} \text{Transfer Efficiency} \\ \text{(Percent)} &= \frac{\text{Volume of Solid Coating on Item} \times 100}{\text{Volume of Solid Coating Consumed}} \end{aligned}$$

3.2.3 Toxic Solvents. Paints and coatings often contain solvents that are toxic at some level. While a person can withstand nominal quantities of most of these ingredients for relatively short periods of time, continuous or overexposure to them may have harmful effects. The potential severity of hazards is greatly magnified when operations are performed in enclosed or confined spaces where toxic solvent concentrations can quickly build up to levels which could produce disability and death. The threshold limit values (TLV) for several commonly used paint and cleaning solvents are given in Table 3. The TLV is a measure of the maximum concentration of solvent vapor in the air which can be tolerated during an 8-hour working day. Since these

concentrations are very low, they are expressed as parts of vapor per million parts of air by volume (ppm). The higher the value, the safer the solvent.

3.2.4 Hazardous Air Pollutants. Some solvents currently used in coatings are on the list of hazardous air pollutants of the Clean Air Act. Restrictions on the use of some of these solvents in coatings are expected. Also, halogenated solvents currently exempted from VOC restrictions because of their photo-chemical inactivity, may be eliminated from use in coatings in the near future because they deplete the upper atmosphere ozone layer. In addition, halogenated solvents can become explosive when in contact with aluminum spray guns.

3.2.5 Binders - Polyurethanes, Coal Tars, Asphalts. Coatings formulated with these resins may require special worker safety measures. Respirators and protective clothing may be needed. The material safety data sheet and the installation's health and safety office should be consulted.

3.2.6 Heavy Metal-Containing Pigments and Additives. Lead- and chromate-containing pigments have been used in paints to provide color and corrosion control. Because of health concerns, a Federal regulation limits lead concentration in new consumer paints to less than 0.06 percent of the weight of the paint solids. Although chromium, as chromate, is not specifically excluded from paints by Federal regulation, the military guide specifications for painting facilities (NFGS-09900, Paints and Coatings and CECS 09900, Painting, General) exclude chromate-containing coatings. Chromate is also on the ACGIH list of suspected carcinogens. Mercury-containing additives have been used to provide in-can bacteria control and paint-film mildew control. Because of health concerns, mercury can no longer be used in paints for residential use. Organic materials are used to control bacterial growth in the can and mildew growth on films.

Organo-tins have been used to control fouling on paints exposed to sea water. Because of the toxic effects of these materials, they have been restricted by the EPA. Copper-containing and some organic materials are being used to provide this protection.

Table 3
TLV and Other Safety Data on Paint and Cleaning Solvents

Solvent	Relative Evaporation Time (1)	Flash Point (2) (deg F)	Evaporative Limits (3) (% by volume)		Threshold Limit Values (4)	
			(min)	(max)	TWA	STEL
Acetone	4	10	2.6	12.8	750	1000
Benzene (suspected carcinogen)	8	10	1.4	7.1	10	32
Butyl Alcohol (Butanol) - skin	70	105	1.4	11.2	50	
Carbon Tetrachloride - skin (suspected carcinogen)	8	not flammable			5	
Diisobutyl Ketone (DIBK)	150	140	0.8	6.2	25	
Ethyl Acetate	8	40	2.5	9.0	400	
Ethyl (Grain) Alcohol (Ethanol)	20	60	4.3	19.0	1000	
Ethyl Ether	1					
Ethylene Dichloride (1,2,dichloroethane)					10	
Ethylene Glycol Monoethyl Ether (Cellosolve) - skin	100	110	2.6	15.7	5	
Ethylenediamine - skin					10	
Ethylene Glycol Monoethyl Ether Acetate (Cellosolve Acetate) - skin	32	130	1.7	no data	5	
Hi-Flash Naptha (Aromatic)	105	105	1.0	7.0		
Isopropyl Acetate	10	50	1.8	7.8	200	250
Isopropyl Alcohol (Isopropanol) - skin	25	65	2.5	12.0	200	250
Methyl (Wood) Alcohol (Methanol) - skin	10	55	5.5	36.5	200	250
Methylene Chloride (Dichloromethane) (suspected carcinogen)	4	not flammable			50	
Methyl Ethyl Ketone (MEK)	8	30	1.8	10.0	200	300
Methyl Isobutyl Ketone (MIBK)	20	65	1.4	7.5	50	75
Mineral Spirits (Petroleum Thinner)	150	105	0.8	7.0		
Refined Kerosene	800	150	0.7	5.0		
Trichloroethylene					50	100
Toluene (Toluol) - skin	15	45	1.3	7.0	50	
Turpentine	100	105	0.8	no data	100	
VM & P Naptha	20	50	1.1	5.9	300	
Water	100	not flammable				
Xylene - skin	35	85	1.0	6.0	100	150

Table 3 (Continued)
TLV and Other Safety Data on Paint and Cleaning Solvents

NOTES: (1) Relative evaporation time is the relative time required for the solvent to completely evaporate, based on an arbitrary value of 1.0 for ethyl ether. The higher the number, the longer the time required for evaporation.

(2) Flash point is the temperature of the solvent in degrees F at which the solvent releases sufficient vapor to ignite in the presence of a flame. The higher the value, the safer the solvent with respect to flash point.

(3) Explosive limits define the range of solvent vapor concentration in air for which the vapor could explode or ignite. Below the minimum concentration and above the maximum concentration, the vapor will not ignite. These values are expressed as the percentage of the solvent vapor in the total volume of vapor plus air. They are also called flammable limits.

(4) Threshold limit values (TLV) were obtained from the American Conference of Governmental Industrial Hygienists (ACGIH), Threshold Limit Values for Chemical Substances and Physical Agents in the Workroom Environment. TWA is the time weighted average exposure limit for an 8-hour workday or a 40 hour week. STEL is the short-term exposure limit for a maximum 15-minute exposure. Both values are expressed as parts per million (ppm) of vapor per volume of air. The higher the value, the safer the solvent. These TLV's are ACGIH's recommendations; Occupational Safety and Health Administration (OSHA) limits may be lower.

3.3 Issues Affecting Surface Preparation

3.3.1 Regulations. This section is aimed at environmental issues. Worker safety issues are discussed in Section 13. Environmental concerns and regulations affecting surface preparation activities involve contamination of the environment and waste disposal. Air regulations (National Ambient Air Quality Standards described in 40 CFR 50-99) that are closely associated with surface preparation and paint removal are the ones for air particulate matter (PM 10) and lead. Air particulate matter is defined as particles with an aerodynamic diameter less than a nominal 10 micrometers. The allowable limit is 150 milligrams per cubic meter, based on a 24-hour average concentration. For lead, the criterion is 1.5 milligrams per cubic meter, based on a 90-day average. Exceeding the PM 10 criterion is more likely during abrasive blasting than other coating operations.

To meet the air regulations described above, containment of work areas may be required. More extensive containment may be needed when removing lead-based paint. The Steel Structures Painting Council (SSPC) SSPC Guide 6I, Containing Debris Generated During Paint Removal Operations, describes five categories of containment. Worker protection must also be considered in designing containment and ventilation systems. Protecting both the environment and the workers is a challenging task.

3.3.2 Waste. Debris resulting from surface preparation may be hazardous waste as defined by Federal solid waste regulations (40 CFR 240-280). Waste may be classified as hazardous if it exhibits any of the following characteristics: ignitability, corrosivity, reactivity, or toxicity, or if it is on a special EPA list. For paint debris, wastes are most likely to be hazardous because of their toxicity (e.g., exceeds limits for lead, cadmium, chromium or mercury) or because of their corrosivity (e.g., pH greater than or equal to 12.5 or pH less than or equal to 2). For toxicity, waste is tested using the toxic characteristic leaching procedure (TCLP) test, described in Appendix II of 40 CFR 261. Waste is classified as hazardous because of toxicity if lead concentration in the leachate exceeds 5 mg/kg, cadmium concentration exceeds 1 mg/kg, chromium concentration exceeds 5 mg/kg, or mercury concentration exceeds 0.2 mg/kg. Paint debris wastes fail most often because of lead. Some industrial paint wastes have also been reported to fail because of chromium or cadmium. Although paint debris may contain low concentrations of mercury from old films in which mercury additives were used to control fungal or bacterial growth, experience indicates that paint waste is unlikely to fail because of mercury toxicity.

3.4 Surfaces Coated With Leaded Paint. The presence of lead in paint films causes health, environmental, and worker safety concerns. This section describes the DOD policy for dealing with leaded-paint associated problems and summarizes DOD guidance. References for specific guidance are given in the References section.

3.4.1 Background

3.4.1.1 Use of Lead in Paint. Most oil-based residential paints contained lead pigments prior to 1940. Lead pigments provided hiding and color (tints of orange, yellow, green, and red). Lead driers were used in both pigmented oil-based paints and varnishes. The concentrations of lead in white or light-colored paints sometimes exceeded 50 percent of the mass of the dry film. Concentrations of lead in paints colored using lead pigments ranged from 1 to about 10 percent of mass of the dry

film. Lead driers were used in concentrations of a few tenths of a percent of the mass of the dry film. The use of lead hiding pigments decreased when titanium dioxide became available in the 1940's, but it was not until 1972 that a Federal regulation set the maximum allowable level of lead in residential paint transported interstate at 0.5 percent. This level was reduced to 0.06 percent for all residential paints in 1978. Thus, lead-based paint abatement is directed primarily at housing built prior to 1978. For steel structures, lead-containing primers (e.g., those pigmented with red lead) have been used on military facilities until recently to control corrosion. Yellow traffic marking paints also may contain lead.

3.4.1.2 Effects of Lead Exposure on Health. Lead can cause a variety of serious adverse health effects. These are detailed in the Strategic Plan for Elimination of Childhood Lead Poisoning, Center for Disease Control, 1991. In children, even low levels of lead increase a child's risk of developing permanent learning disabilities, reduced concentration and attentiveness spans, and behavior problems. Adverse health effects may occur before the appearance of any symptoms. Symptoms include loss of appetite, difficulty sleeping, irritability, fatigue, headache, moodiness, joint and muscle aches, and metallic taste in the mouth. High levels of lead concentrations can result in severe damage to the blood forming, nervous, urinary, and reproductive systems of the body. Lead poisoning from leaded paint typically occurs due to the ingestion of leaded paint or lead-contaminated dust into the body through the digestive system or inhalation. Peeling and chipping of leaded paint or abrasion of surfaces of leaded paint are primary pathways for lead poisoning.

3.4.1.3 Environmental Issues. Lead containing materials are a potential hazard to the environment when released in an uncontrolled manner. Proper containment of painting operations involving leaded paint and proper disposal of the debris are required to prevent contamination of soil, water and air. Debris generated during a maintenance painting job involving leaded paint may contain enough lead to be classified as a hazardous waste. If so, storage, transportation, treatment, and disposal of waste is governed by Federal regulations and applicable local and State regulations.

3.4.1.4 Occupational Safety Issues. Workers involved in leaded-paint removal are at risk for lead poisoning. Poisoning can result when the leaded paint is disturbed in a way that creates uncontrolled dust or small particles such as in sanding, open-abrasive blasting, chipping, grinding, and burning. The lead dust makes its way into an individual in many ways, including eating dust-contaminated food, hand-to-mouth activity, smoking cigarettes, and breathing dust-contaminated air. This

hazard was addressed by in a rule published May 4, 1993 in the Federal Register, 29 CFR Part 1926.62. This rule amended their regulations for construction workers. It reduced the permitted level of exposure to lead for construction workers from 200 micrograms per cubic meter of air as an 8-hour TWA to 50 micrograms per cubic meter of air. Special worker-protection requirements are mandated when surfaces coated with leaded paint are disturbed, unless existing data show that the requirements are not needed. Training for workers aimed at both residential and non-residential activities is available from EPA-sponsored training centers and other private training groups.

3.4.2 Definitions. For the purposes of this discussion, residential structures are Government owned or leased family housing, child development centers, family child care homes, schools, playgrounds, and similar facilities. Target residential facilities are those constructed prior to 1978. Facilities constructed or included in whole-house revitalization or similar major rehabilitation projects since 1978, if paint coatings were removed or replaced, are considered free of lead-based paint. Non-residential structures include office buildings, warehouses, water towers, and the like. Lead-in-paint terms are defined in the following way:

a) Leaded paint - paint containing lead compounds as an ingredient at potentially hazardous concentrations.

b) Lead-based paint - a legislative term, defined by the U.S. Lead-Based Paint Poisoning Prevention Act as existing paint in residential structures having lead concentrations of 1 milligram per square centimeter or greater.

c) Lead-containing paint - a regulatory term, defined by the Consumer Product Safety Commission as residential paint (wet) offered for sale having a lead concentration greater than 0.06 percent by weight of the film solids.

3.4.3 DOD Policy/Instruction. The following sections summarize policy documents issued by DOD and military components for residential and non-residential structures (Table 4).

3.4.3.1 Residential Structures. DOD's policy memorandum, Lead-Based Paint (LBP) - Risk Assessment, Associated Health Risk in Children, and Control of Hazards in DOD Housing and Related Structures, describes the DOD policy for residential structures. A DOD instruction will also be developed. The DOD policy is to provide occupants of DOD residential structures (to include leased structures) a safe and healthful environment. The memorandum covers 1) assessing health risk from LBP and 2) controlling LBP hazards in DOD housing and related structures.

The memorandum states that DOD will assess and correct all recognized health-hazards in DOD residential structures and will negotiate for assessment and control of LBP in DOD-leased facilities. Control of LBP will be by either in-place management (IPM) or removal. Removal is to be performed when IPM cannot reliably control the lead hazard, or when removal is cost effective during renovation or upgrade. Specific procedures for carrying out the DOD policy are described in each of the military component's documents shown in Table 4. The information is summarized in par. 3.4.4.

Table 4
DOD and Military Component's Policy Documents on Lead-Based Paint

Document No.	Document Name	Scope	Point of Contact
DOD Memorandum, 24 Nov 1992	Lead-Based Paint (LBP) - Risk Assessment, Associated Health Risk in Children and Control of Hazards in DOD Housing and Related Structures	Residential	ODASD (Env/Sfty & Occ Hlth)
U.S. Army, Memorandum 28 April, 1993	Lead-Based Paint Policy Guidance	Residential	CEHSC-FB-S, Bryan J. Nix
U.S. Air Force, 24 May 1993, HQ USAF/CC	Air Force Policy & Guidance on Lead-Based Paint in Facilities	Residential and Industrial	HQ AFCEA\ENE, Barry Kollme
U.S. Navy, 9 Nov 1992 Memorandum 11101 FAC 08/T1822B	Navy Family Housing Lead-Based Paint/Asbestos Inventory Program	Residential	NAVFAC (Fam Hsg), Richard Hibbert
U.S. Navy, Design Policy Letter, DPL-09B-0001	Lead-Containing Paint on Non-Residential Structures	Non-Residential	NAVFAC Code 1004, Bruce Bell

3.4.3.2 Non-Residential. Although there is no corresponding DOD memorandum for non-residential structures, the Air Force, Army and Navy have policy documents, referenced above, which prohibit the use of lead-containing paint on non-residential structures. (The Navy allows a slightly higher amount of lead in coatings for corrosion control - less than 0.3 percent by mass of the dry film - to account for possible contamination of zinc pigments by lead.) The Navy policy also states that surfaces covered with intact leaded paint do not represent a hazard until there is a need to remove or physically disturb the existing paint. Whenever surfaces covered with leaded paint are

disturbed, for example during repair or as part of an operations and maintenance activity, special precautions may be required to ensure the safety of the workers and prevent contamination of the surroundings.

3.4.4 General Description of Lead-Based Paint Procedures. Identification, risk assessment, and abatement procedures for lead-based paint in residential and non-residential structures may not be the same because of the differences in the way the structures are used and maintained.

3.4.4.1 Inspection/Assessment. The first step of inspection/assessment is to prioritize facilities to ensure that those most likely to have the worst lead-based paint problems are inspected first. Next, painted surfaces (using the Department of Housing and Urban Development (HUD) guidelines list of components and surfaces) are inspected to identify lead-based paint, lead-containing dust or lead-based paint hazards. For paint, portable x-ray fluorescence devices are used in conjunction with limited sampling of surfaces for laboratory atomic absorption spectrometric analysis. The data are analyzed to determine which surfaces present a high risk (e.g., peeling, chipping) to occupants. Both IPM and removal are part of all the strategies. The objective of the IPM is to reduce excessive exposure to lead and protect occupants from lead poisoning in facilities pending total removal of lead-based paint.

For non-residential structures, there are no written procedures for choosing surfaces for testing for leaded paint. The primary circumstance in which paint is tested on non-residential structures is just prior to preparing a contract for maintenance painting. At that time it is important that samples be taken for laboratory analyses to determine whether the paint contains lead. This is because special worker safety and environmental controls may be needed during coating maintenance to protect workers and the environment. Environmental controls include containment of debris to prevent it from polluting air, soil, or water. Although there are no standard procedures for this inspection, it is important that enough samples be taken to obtain a representative lead concentration of the paint. All layers of the paint film must be included in the samples. Testing should also be undertaken prior to maintenance and operation activities that will cause significant amounts of leaded paint to enter the environment. Both worker safety and local containment of debris are of concern.

3.4.4.2 In-Place Management (IPM). IPM refers to a broad range of strategies and methods for controlling exposures to lead and preventing poisonings from lead in paint pending permanent removal. Because of the high number of facilities with lead-

based paint, immediate removal of all lead-based paint will not be possible. IPM includes cleaning up lead-contaminated dust, chipping, and peeling paint, and taking steps to stabilize lead-based paint to prevent additional peeling paint. IPM also includes monitoring surfaces painted with lead-based paint and appropriate periodic clean up of lead-contaminated dusty surfaces. It also requires maintenance and repair work be carried out with attention to the potential for creating lead hazards.

3.4.4.3 Removal. The Navy Guide Specification, NFGS-13283, Removal and Disposal of Lead-Containing Paint, and the Army Corps of Engineers Guide Specification (CEGS) 02090, Removal of Lead-Based Paint, provide guidance for removal of leaded paint in both residential and non-residential structures. The following issues must be considered for both types of structures:

- a) Occupant safety
- b) Building contents
- c) Worker safety
- d) Environmental protection (containment of debris)
- e) Cleanup
- f) Waste disposal

Detailed guidance for paint removal from residential structures can be found in the HUD guidelines. The SSPC has prepared three documents dealing with issues pertaining to removal of lead-containing paint from industrial structures: SSPC Guide 6I; SSPC Guide 7I, Disposal of Lead-Contaminated Surface Preparation Debris, and SSPC QP2, Evaluating the Qualifications of Painting Contractors to Remove Hazardous Paint.

3.4.4.4 Operations and Maintenance. Special operations and maintenance activities may disturb lead-containing paint, for example repairing a light fixture. In these situations, special precautions are needed to:

- a) Protect the worker
- b) Control the spread of the dust that is generated
- c) Ensure that debris is collected, handled, and disposed of properly

3.4.5 Waste Disposal. Wastes from some painting operations involving leaded paint may be classified as hazardous waste under the Resource Conservation and Recovery Act (RCRA). Regulations resulting from this act can be found in 40 CFR 240-280. For lead-containing wastes, these regulations require that a representative sample of the waste be tested using a standard procedure, the TCLP. If the amount of lead that is leached from the waste exceeds 5 mg/kg (ppm), the waste is classified as hazardous. In addition, if alkaline chemical strippers are used for removal, the waste may fail because of its alkalinity. If the debris is classified as a hazardous waste, special procedures are required for handling, transporting, treating and disposal. These requirements are described in detail in 40 CFR 260-268. The cost for disposing of hazardous waste is many times greater than for non-hazardous waste.

3.4.6 Demolition of Buildings Containing Lead-Based Paint. Maintenance painting is not directly involved in demolition of buildings containing leaded paint. However, sampling and testing procedures to determine whether debris is hazardous due to the presence of lead are similar. In addition, restrictions on sorting the waste into hazardous and non-hazardous groups are similar. Information on disposing of demolition debris is available in guide specification (Sampling Protocol - Building Demolition Debris and Buildings Painted With Lead-Based Paint) prepared by HSHB-ME-SH, U.S. Army Environmental Hygiene Agency, Waste Disposal Engineering Division, Aberdeen Proving Ground, MD 21010-5422.

3.4.7 Sources of Detailed Information. Details of procedures for removing, abating, and managing existing lead-based paint on surfaces can be found in the references listed below:

a) Lead-Based Paint: HUD Interim Guidelines for Hazard Identification and Abatement in Public and Indian Housing (can be obtained by calling 1-800-245-2691)

b) Air Force policy and guidance

c) Army policy and guidance

d) Navy policy and guidance

Section 4: SELECTION OF COATINGS

4.1 Available Guidance. Guidance for specifying coating systems for original or maintenance painting of shore facilities is found in specialized guide specifications such as NFGS-13283 or CEFS 09900 or in Air Force Engineering Technical Letters. In these documents, surface preparation for the primer is usually considered a part of the system because of its importance in system performance and is included in the guidance. Recommendations for coating systems are also available from an Army, Navy, or Air Force coatings specialist. These specialists are particularly helpful when criteria for a specialized job are not available or when guidance documents are out of date.

4.2 Selection Criteria. The best selection of a coating system for a particular service is determined by a variety of factors. These include desired properties, work requirements and limitations, safety and environmental restrictions, compatibilities, and costs.

4.2.1 Desired Film Properties. In selecting a coating system, the first consideration is the desired properties of the system for the particular service. Desired properties may include one or more of the following aspects:

- a) Resistance to exterior weathering (chalking; color and gloss retention)
- b) Water, fuel, or chemical resistance
- c) Abrasion, heat or mildew resistance
- d) Appearance (color, gloss, and texture)
- e) Drying time
- f) Ease of application and maintenance

4.2.2 Work Requirements or Limitations. The following work requirements or limitations may have to be considered:

- a) Type of surface preparation
- b) Access to work
- c) Drying times
- d) Necessary applicator skills
- e) Necessary equipment

f) Scaffolding for access to work

4.2.3 Safety and Environmental Restrictions. It will be necessary to conform to all prevailing safety and environmental regulations concerning materials and processes to be used for surface preparation and for coating application. These regulations are discussed more fully in Section 3 of this handbook.

4.2.4 Compatibilities. Coating systems must be compatible with the surfaces to which they are applied. Coating incompatibility can cause failures at or just after application or after a much longer time. Failures occurring just after application are due to solvent incompatibility or wetting problems. Failures associated with slow chemical reactions, such as those occurring between alkaline surfaces (e.g., concrete and galvanized steel) and oil-based paints or mechanical property mismatches (e.g., a rigid coating applied over a more flexible one) cause failure in a longer timeframe. The failure more often is peeling. For existing coatings being repainted, compatibility generally means that topcoats should be of the same generic type or curing mechanism as undercoats. One exception to this rule is inorganic zinc coatings. Since inorganic zinc coatings frequently do not bond well to themselves, it is safest to repair them with zinc-rich organic coatings.

A simple test to classify coatings is to determine solvent sensitivity using an methylethyl ketone (MEK) or acetone rub test. To do this, soak a cloth in MEK or acetone, rub it against the existing paint, and visually check for pick up of paint. The paint is classified as "solvent soluble" if paint is picked up, and as "solvent insoluble" if not.

Another practical method of ensuring topcoat solvent compatibility is to coat a small test area of the existing coating with the paint selected for the work. If situations permit, this test is preferred over the MEK rub test because it is specific for the surface to be repainted. The test area should be visually inspected the following day (or preferably after 3 or more days) for bleeding of undercoat, wrinkling, loss of adhesion, or other coating defects. Although most incompatibility problems are apparent in a couple of days, some types of incompatibility may not become apparent for several months or until after a change of seasons. These types are usually associated with mechanical film properties.

4.2.5 Costs. Life cycle cost has always been one of the most important considerations in selection of coating systems. Life cycle costs include original surface preparation, materials, and application and necessary maintenance throughout the life of the

coating system. Today, the expense of containment of old paint during its removal and disposal of debris that is often considered to constitute hazardous waste must be included. This usually means that the system with the maximum maintainable life is the best choice.

4.3 Specifications for Lead- and Chromate-Free Coatings With VOC Limits. The coating specifications listed below in Table 5 are lead- and chromate-free and have limitations on their contents of VOC.

Table 5
Lead- and Chromate-Free Coating Specifications With VOC Limits

Latex Coatings	
Listed latex coatings are available with a VOC content of no more than 250 grams per liter unless otherwise specified	
TT-P-19	Exterior acrylic emulsion coating, available in a wide variety of colors and flat gloss finishes
TT-P-29	Interior latex paint, flat, available in white and tints
TT-P-650	Interior latex primer coating for gypsum board or plaster
TT-P-1510	Latex exterior flat finish coating, available in a variety of colors
TT-P-1511	Latex interior coating, available in gloss and semigloss in white and tints
TT-P-1728	Latex, interior, flat, deep-tone coating
TT-P-001984	Primer, latex, for wood
TT-P-002119	Latex high-traffic coating, available in flat and eggshell and a variety of colors
TT-E-2784	Acrylic emulsion exterior enamel, gloss and semigloss, available in a wide variety of colors
MIL-E-24763	Acrylic water-emulsion coating intended for shipboard use, available in 275 and 340 grams per liter VOC classes; high, medium, low, and flat glosses; and a limited number of colors
MIL-P-28577	Corrosion-resistant latex primer for metals
Stains	
MIL-P-28578	Waterborne acrylic semigloss finish, available in a wide variety of colors
TT-S-001992	Exterior latex stain, semi-transparent and opaque, available in a variety of colors
Clear Floor Finishes	
A variety of clear floor finishes are available from the Maple Flooring Manufacturers Association (MFMA) specifications, <u>Heavy-Duty and Gymnasium Finishes for Maple, Beech, and Birch Floors</u> . Suppliers on the attached list must be contacted to determine VOC content.	
Oil and Alkyd Coatings	
SSPC PAINT-25	Corrosion-resistant raw linseed oil and alkyd primer, usually available at 300 grams per liter VOC but no requirement listed

Table 5 (Continued)
Lead- and Chromate-Free Coating Specifications With VOC Limits

TT-P-25	Oil-based primer for wood, normally available with a VOC content less than 350 grams per liter
TT-P-31	Red and brown oil ("roof and barn") paint, usually available with 250 grams per liter VOC content but no requirement specified
TT-E-489	Alkyd enamel, with 420 grams per liter VOC limitation, available only in gloss, but in a wide variety of colors
TT-P-645	Corrosion-resistant alkyd primer, with a 340 VOC limitation
TT-P-664	Corrosion-inhibiting alkyd quick-dry primer, with a 420 grams per liter VOC limitation
MIL-E-24635	Silicone alkyd enamel, available in limited colors, 275, 340, and 420 grams per liter VOC types, and high, medium, low, and flat gloss classes
MIL-P-28582	Alkyd primer normally available at less than 350 grams per liter
Epoxy Coatings	
MIL-P-24441	Epoxy-polyamide, two- and three-coat systems, available in types with 340 VOC and limited colors
MIL-P-53022	Fast-dry epoxy primer with 420 grams per liter maximum VOC content
MIL-P-85582	Waterborne epoxy primer with 340 grams per liter maximum VOC content
Textured Coatings	
TT-C-555	Waterborne or oil- or rubber-based textured coating available at 250 grams per liter
Urethane Coatings	
MIL-C-85285	High-solids aliphatic urethane coating, with 340 and 420 grams per liter VOC types, available in a variety of colors and in glass and semigloss
Zinc-Rich Coatings	
MIL-P-24648	Zinc-rich coating, aqueous and organic solvent types, self-curing and post-curing classes, organic and inorganic vehicles, with 340 grams per liter maximum VOC content

4.4 Recommendations for Different Substrates. This portion of Section 4 provides general recommendations for wood, concrete and masonry, steel, galvanized steel, and aluminum surfaces. The recommended dft in mils is provided for coating specification recommended for a particular substrate. More detailed recommendations for coating particular structures are presented in Section 5 of this handbook. Referenced standards for coatings provide for lead- and chromate-free products that are low in VOCs. Although such requirements may not be necessary at all activities, such requirements may occur in the near future.

In making local repairs of damaged coatings, loose paint should be removed by scraping with a putty knife before lightly sanding or abrasive blasting any exposed substrate and feather-edging existing sound paint to obtain a smooth transition with the repaired area. Coats of repair material should be extended 1 inch onto the surrounding sound coating.

4.4.1 Recommendations for Wood. Oil-based and waterborne coatings and stains (frequently called latex) perform quite well on new wood. A two-coat system, paint or stain, is normally applied. However, as additional coats are applied to resurface or repair weathered paint, the film thickness may become sufficient to reduce the total flexibility to the point that results in disbonding of the total paint system from the surface. Thus, when topcoating or making localized repairs, no more coating should be applied than necessary to accomplish the desired goal.

Surface preparation of new wood normally consists of lightly hand sanding or power sanding, carefully controlled so that it does not damage the wood. Sanding is also appropriate for preparing weathered surfaces for refinishing and for spot repairing areas of localized damage.

4.4.1.1 Oil-Based Paints. Historically, wood has been successfully painted with oil-based products that penetrate the surface well. These coatings are very easy to apply.

Oil-Based Paint System for Wood

<u>Surface Preparation</u>	<u>Primer</u>	<u>Topcoat</u>
Sand	one coat TT-P-25 or MIL-P-28582 2 mils dft	one-two coats MIL-E-24635 or TT-P-102 2 mils dft per coat

4.4.1.2 Water-Emulsion Paints. More recently, latex coatings have been found to be very effective in providing attractive, protective finishes. They are also less affected by moisture than are oil-based finishes and are generally more flexible and thus less susceptible to cracking as the wood swells and contracts with moisture changes.

A problem sometimes arises when repairing or topcoating existing smooth alkyd coatings with latex paints. To obtain good intercoat adhesion, it may be necessary to lightly sand the existing paint and/or apply a surface conditioner containing tung oil or some other oil that wets surfaces well before applying the first coat of latex paint.

Waterborne Paint System for Wood

<u>Surface Preparation</u>	<u>Primer</u>	<u>Topcoat</u>
Sand	one coat TT-P-001984 1.5 mils dft	one-two coats TT-E-2784 or other appropriate latex paint in Table 5 1.5 mils dft per coat

4.4.1.3 Semi-Transparent Stains. Because oil-based and waterborne paints form continuous films, they may form blisters or disbond because of moisture in the wood attempting to escape. Semi-transparent stains do not form continuous films on wood and so do not have this problem. Thus, they are a good alternative on new wood. Additional coats applied over the years or heavy-bodied stains will, however, form continuous films.

Stains for Wood

<u>Surface Preparation</u>	<u>Primer</u>	<u>Topcoat</u>
Sand	one coat TT-S-001992 1.5 mils dft	one coat TT-S-001992 1.5 mils dft

4.4.1.4 Clear Floor Finishes. A variety of clear floor finishes are available from MFMA Heavy-Duty and Gymnasium Finishes for Maple, Beech, and Birch Floors. Suppliers on the attached list must be contacted to determine VOC content. Surface preparation for hard wood floors is described in detail in NFGS-13283 or CEGS 09900.

4.4.2 Recommendations for Concrete and Masonry Surfaces. Concrete and masonry surfaces, as well as those of stucco, plaster, wallboard, and brick, can be coated with a variety of systems depending upon the desired purpose and appearance.

Surface preparation is usually accomplished by power washing with aqueous detergent solution to remove dirt and other loose materials. Any oil or grease will have to be removed by solvent or steam cleaning; any mildew, by scrubbing with bleach; and any efflorescence or laitance, by brushing, followed by acid treatment. These techniques are described more fully in Section 6.

4.4.2.1 Waterborne Coatings. A two-coat waterborne (latex) system provides an attractive breathing film that is normally less affected by moisture in the concrete than non-breathing systems. The latex material is a self-primer in this service,

unless otherwise stated. Alkyd and other oil-based coatings should not be applied directly to concrete or masonry surfaces, because the alkalinity in the concrete will hydrolyze the oil in the binder and cause the coating to peel. However, they can be applied over concrete or masonry surfaces primed with waterborne coatings to produce a tougher, more washable finish.

Waterborne Coating System for Concrete/Masonry

Surface

Preparation

Primer/Topcoat

Power wash

two coats of TT-E-2784 or other appropriate* waterborne coating
1.5 mils dft each coat

*Interior or exterior product, desired gloss and color available. TT-P-29 is less expensive and normally used on interior surfaces.

4.4.2.2 Elastomeric Coatings. Elastomeric, waterborne acrylic coating systems also perform well to seal and protect concrete/masonry surfaces and are normally very low in VOCs. They can successfully bridge fine or larger caulked cracks. There are no Government or military specifications for them.

Elastomeric Waterborne Acrylic System for Concrete or Masonry

Surface

Preparation

Primer

Topcoat

Power wash

one coat primer recommended by supplier of elastomeric coating dft varies with supplier

one coat elastomeric acrylic coating
10 - 20 mils dft

4.4.2.3 Textured Coatings. Textured coatings system can bridge fine cracks and waterproof from wind-driven rain. They are normally applied over a primer recommended by the supplier to insure good adhesion. They are available in a variety of textures and may be waterborne or oil or rubber-based products with a VOC limit of 250 grams per liter.

Textured Coating System for Concrete or Masonry

<u>Surface Preparation</u>	<u>Primer</u>	<u>Topcoat</u>
Power wash	one coat primer recommended by supplier of textured coating dft varies with supplier	one coat TT-C-555 20 - 30 mils dft

4.4.2.4 Epoxy Coatings. A two-coat epoxy system will seal and protect concrete/masonry surfaces well. An aliphatic urethane finish coat should be used rather than the second epoxy coat on exterior surfaces to improve the weatherability.

Exterior Epoxy/Urethane System for Concrete or Masonry

<u>Surface Preparation</u>	<u>Primer</u>	<u>Topcoat</u>
Power wash	one coat MIL-P-24441 Formula 15 3 mils dft	MIL-C-85285 Type II 2 mils dft

Interior Epoxy System for Concrete or Masonry

<u>Surface Preparation</u>	<u>Primer</u>	<u>Topcoat</u>
Power wash	one coat MIL-P-24441 Formula 150 3 mils dft	one coat MIL-P-24441 of another color 2 mils dft

4.4.3 Recommendations for Steel. Presently, a high-performance coating system is recommended to prolong the service before it becomes necessary to remove and replace it. Costs in coating removal, especially where there are restrictions on abrasive blasting, are very high.

Abrasive blasting is always preferred to alternative methods of preparing steel surfaces for painting. It cleans the steel and provides a textured surface to promote good primer adhesion. A commercial blast (SSPC SP 6) is normally adequate for alkyd and epoxy primers for a moderate environment. A near-white blast (SSPC SP 10) is required for epoxies, including zinc-rich epoxies, exposed to a severe environment such as marine atmospheric or water or fuel immersion. Some manufacturers may specify a white metal blast (SSPC SP 5) for particular coatings for special applications. It is important that a contract specification does not conflict with the coating manufacturer's

written directions. A white metal blast (SSPC SP 5) is recommended for zinc-rich inorganic primers. If abrasive blasting cannot be done, then power tool cleaning to bare metal (SSPC SP 11) is recommended. It provides a surface cleanliness and texture comparable to those of a commercial blast (SSPC SP 6). Hand tool cleaning (SSPC SP 2) or power tool cleaning, however, may be adequate in making localized repairs.

4.4.3.1 Alkyd Systems. In the past, most military steel structures with atmospheric exposures were coated with an alkyd or other oil-based system. Three-coat alkyd systems provided adequate protection in moderate atmospheric service. On new painting, they are being replaced in significant part by epoxy systems that provide longer protection. Alkyd systems, however, will still be used in large volume for repairing old deteriorated alkyd systems.

Alkyd Coating System for Steel

<u>Surface Preparation</u>	<u>Primer</u>	<u>Topcoat</u>
SSPC SP 6	one coat TT-P-645 or SSPC PAINT 25 2 mils dft	two coats MIL-E-24635 or TT-E-489 2 mils dft

4.4.3.2 Epoxy Coating Systems. A three-coat epoxy system provides good interior service in harsh as well as moderate environments. An aliphatic urethane finish system is used in place of the third epoxy coat in exterior service to provide greater resistance to deterioration by ultraviolet light. Several different epoxy mastic systems, some aluminum-filled, have been used successfully on steel structures. However, there is no specification for one at this time.

Epoxy System for Exterior Steel

<u>Surface Preparation</u>	<u>Primer/Mid Coat</u>	<u>Topcoat</u>
SSPC SP 6 or 10	one coat each MIL-P-24441 Formulas 150 and 151 3 mils dft per coat	one coat MIL-C-85285 Type II 2 mils dft

Epoxy System for Interior Steel

<u>Surface Preparation</u>	<u>Primer/Mid Coat</u>	<u>Topcoat</u>
SSPC SP 6 or 10	one coat each MIL-P-24441 Formulas 150 and 151 3 mils dft per coat	one coat MIL-P-24441 of desired color 3 mils dft

4.4.3.3 Zinc-Rich Coatings. Good protection from corrosion and abrasion can be provided by zinc-rich inorganic coatings. They perform well untopcoated in a variety of environments except acidic or alkaline. They may be topcoated with an acrylic latex finish coat to provide a variety of color finishes. Epoxy (for interior) or epoxy and aliphatic urethane (for exterior) topcoats may also be used. Localized repair of inorganic zinc systems is usually accomplished with a zinc-rich organic coating to permit good bonding to any exposed steel, inorganic coating, or organic topcoats.

Zinc-Rich System for Steel

<u>Surface Preparation</u>	<u>Primer</u>	<u>Topcoat</u>
SSPC SP 5	1-MIL-P-24648 Composition B (inorganic), 3 mil dft (Composition A (organic) can be used when a more "forgiving" system is needed, refer to pars. 2.3.8 and 2.3.9)	None, or one or more coats of acrylic or latex, epoxy, etc.

4.4.4 Recommendations for Galvanized Steel. Galvanized steel corrodes very slowly in moderate environments but may be painted with organic coating systems to provide color or additional corrosion protection, particularly in severe environments. It should never be coated directly with an alkyd paint, because the alkalinity on the surface of the galvanizing will hydrolyze the oil in the binder, degrading the binder, and cause paint peeling.

New galvanizing should be solvent or steam cleaned (SSPC SP 1, Solvent Cleaning) to remove any grease or oil before coating. Older, untopcoated galvanizing should be power washed to remove any dirt or loose zinc corrosion products. Any loose coatings should also be removed by power washing or scraping and sanding to produce a clean, sound surface. Rust should be removed by waterblasting or careful abrasive blasting to limit the removal of galvanizing.

4.4.4.1 Epoxy Systems. Two coats of epoxy will provide long-term protection to galvanizing in interior service, as will one coat of epoxy and one coat of aliphatic urethane to galvanizing in exterior service.

Epoxy Coating System for Exterior Galvanizing

<u>Surface Preparation</u>	<u>Primer</u>	<u>Topcoat</u>
SSPC SP 1	one coat MIL-P-24441 Formula 150 3 mils dft	one coat MIL-C-85285 Type II 2 mils dft

Epoxy Coating System for Interior Galvanizing

<u>Surface Preparation</u>	<u>Primer</u>	<u>Topcoat</u>
SSPC SP 1	one coat MIL-P-24441 Formula 150 3 mils dft	one coat MIL-P-24441 of desired color 3 mils dft

4.4.4.2 Waterborne System for Galvanizing. Two coats of latex paint will provide a pleasing appearance and good protection to galvanized steel in moderate environments. They are easy to apply.

Waterborne Coating System for Galvanizing in Moderate Environment

<u>Surface Preparation</u>	<u>Primer</u>	<u>Topcoat</u>
SSPC SP 1	one coat TT-E-2784 1.5 mils dft	one coat TT-E-2784 * 1.5 mils dft

* Other commercially available acrylic latex systems will also perform well.

4.4.5 Recommendations for Aluminum. Aluminum surfaces corrode very slowly in moderate environments. They may be coated to provide color or additional protection, particularly in severe environments. Epoxy and epoxy/urethane systems perform well in interior or exterior service, respectively. Alkyd systems usually require surface pretreatments containing toxic materials.

Because aluminum surfaces are relatively soft, they should not be cleaned by blasting with conventional abrasives or grinding to avoid damage. Any grease or oil should be removed by solvent or steam cleaning (SSPC SP 1). Dirt and other loose

contaminants should be removed by power washing. Existing coatings are best removed by careful blasting with a soft abrasive (e.g., plastic). Alkaline strippers should never be used, because they will attack the aluminum.

Coating System for Aluminum

Surface
Preparation

See above

Primer

one coat MIL-P-24441
Formula 150 or
MIL-P-53022
3 mils

Topcoat

one-two coats
MIL-C-85285 Type II
2 mils per coat

Section 5: COATING SYSTEMS FOR SPECIFIC USES

5.1 General. Section 4 of this document provides general guidance for the selection of coating systems for wood, concrete/masonry, steel, galvanized steel, and aluminum surfaces. This section provides more detailed information on systems for specific structures or components of structures. These structures include metal storage tanks, pipe lines, towers, waterfront structures, siding, fences, and hot surfaces; concrete storage tanks, swimming pools, catchment basins, pavements, and floors; and wood floors. This section also describes problems associated with mildew on painted surfaces.

5.2 Painting New Construction. The designer of the first coating system for a new fuel tank, pipe line or other constructed facility has the unique opportunity to specify a system that can provide the best service. Much of the coating system - surface preparation, priming and in some cases application of the complete coating system - can be carried out in a shop environment where the environmental and application parameters can be controlled. By controlling these conditions, the surface can be very well prepared and the film properties obtained after curing are optimum. Further, worker safety and environmental controls may be more easily accomplished. Since the cost difference of a white metal blast as compared to a near-white blast may be small for new steel, and since the cost of the "best" materials may not be much greater than the cost of "poor" materials, the use of these procedures and materials should be considered when selecting the coating system. Maintenance painting is always more difficult than shop painting and frequent maintenance painting on constructed facilities may interfere unacceptably with the mission of the structure. Thus, in summary, it is recommended that high-performance systems be specified on new construction.

5.3 Fuel Storage Tanks. Steel fuel tanks are coated to keep the fuel clean and prevent leaks resulting from corrosion. Leaks can cause fires or serious contamination of soils or ground waters. Underground steel fuel tanks should also be cathodically protected or double walled to meet Department of Transportation requirements directed at environmental protection from fuel leaks.

For new tanks in most environments, effective performance of most chemically cured (e.g., epoxies and polyurethanes) has been obtained with a near-white finish (SSPC SP 10) before coating. However, it is essential that the surface preparation specified for a coating not be in conflict with that provided by the coating manufacturer on the written coating data

sheet. In some cases, a coating manufacturer may state that a coating should only be used over a white-metal finish (SSPC SP 5). After application of the total system, it should be checked for holidays with a low-voltage holiday detector as described in the National Association of Corrosion Engineers (NACE) RPO188, Standard Recommended Practice, Discontinuity (Holiday) Testing of Protective Coatings. Any holidays that are located should be repaired.

Repair of damaged coatings will vary somewhat with the existing coating system. Normally, repairs are made with the type of coatings already on the tanks. If these are not available, another compatible coating system must be used. Compatibility of coatings can be determined as described in par. 5.6.2. Localized exposed steel should be spot abrasively blasted to an SSPC SP 10 condition and the intact coating surrounding these areas should be brush-off blasted (SSPC SP 7) to a 2-inch width. The patch of the same or a compatible coating system should be applied to steel and extend 2 inches onto the cleaned intact coating.

5.3.1 Interiors of Steel Fuel Tanks. Interiors of steel storage tanks should be cleaned as described in NFGS-13219, Cleaning Petroleum Storage Tanks, and inspected regularly. Because it may not be possible to do this conveniently, it is critical that they receive long-lasting, high-performance interior coating systems. Corrosion occurs most frequently on the floors of the tanks, where water is always present despite its frequent removal from sumps. Thus, the bottoms of steel tank interiors should be measured for adequate thickness before blasting and recoating is initiated. It may be necessary to fill pits with weld metal, apply a false bottom of fiberglass-reinforced plastic as described in NFGS-13217, Fiberglass-Plastic Lining for Steel Tank Bottoms (for Petroleum), or install a new replacement steel bottom. All steel storage tank interiors should be given a near-white blast (SSPC SP 10) immediately prior to priming. For many years, fuel tank interiors have been successfully lined with a three-coat epoxy system with a total dry film thickness of 9 mils. Coats of epoxy-polyamide conforming to Formulas 150, 151, and 152 of MIL-P-24441 have been the epoxy system most frequently used to line military steel fuel tanks. It is described in NFGS-09973, Interior Coating System for Welded Steel Petroleum Storage Tanks.

More recently, a urethane system was developed for lining steel fuel tanks. As described in NFGS-09970, Interior Coatings for Welded Steel Tanks (for Petroleum Fuels), it consists of a pretreatment wash primer, a polyurethane primer, a polyurethane intermediate coat, and a finish coat. The finish

coat may be a polyurethane or a special fluorinated polyurethane. These coatings currently exceed the VOC limit of 340 grams per liter that exists in many locations, the fluorinated polyurethane coating is very expensive, and the pretreatment wash primer and the primer contain chromate. However, because of the reported much longer life of the system with the fluorinated polyurethane finish, it is recommended for Navy fuel tanks, wherever it is legal to use it.

After application of each coat of interior paint, tank interiors must be thoroughly ventilated to remove organic solvent vapors and to assist in curing (solvent release) of coatings. Ventilation requirements vary with tank size, shape, and number of openings. Safety requirements and instructions of coating manufacturers should be followed. Heated air can also be used to accelerate curing of coatings. Blasting and painting hoses, as well as other electrical equipment, should be grounded and sparkproof. The local industrial hygienist can provide information on health and safety requirements for the lining operation. It is especially important to require holiday testing of the interior tank coatings. In this way, small defects can be found and repaired, preventing sites for premature initiation of corrosion.

5.3.2 Exteriors of Steel Fuel Tanks. The exterior coating of steel fuel tanks is described in NFGS-09971, Exterior Coating System for Welded Steel Petroleum Storage Tanks. For new tanks, a system that has performed well is two coats of epoxy-polyamide (e.g., MIL-P-24441 Formulas 159 and 151) and a finish coat of aliphatic polyurethane (e.g., MIL-C-85285) to a total dry film thickness of at least 8 mils. The recommended surface preparation is an SSPC SP 10 near-white blast. Refer to par. 4.4.3 for maintenance painting of exterior tanks.

5.4 Steel Water Tanks. Newer steel water storage tanks have welded sections. Older riveted or bolted tanks are still used, however, at some activities. The seam areas of such tanks are much harder to completely coat. Cathodic protection, as described in NFGS-13112, Cathodic Protection System (Steel Water Tanks), CECS 16641, Cathodic Protection System (Steel Water Tanks), and MIL-HDBK-1004/10, Electrical Engineering Cathodic Protection, is recommended for water tank interiors to supplement the protection afforded by coatings. Corrosion of cathodically protected water tanks generally is usually concentrated at the top of the tank along sharp edges, crevices, and beams supporting the roof, where cathodic protection does not occur. Thus, it is important to coat and inspect these areas especially well.

5.4.1 Interiors of Steel Water Tanks. Most states presently require or are expected to require the use of coating systems approved by the National Sanitation Foundation (ANSI/NSF Standards 60 and 61) for the lining of potable water tanks. Coating approval is based on tests (NSF Standards 60 and 61) for leaching of toxic materials. The tests do not address durability of the coatings for water immersion service. The coatings are usually epoxies. In states that have no requirements, the three-coat epoxy-polyamide system described in par. 5.3.1.1 for the interiors of steel fuel tanks can also be used, except that Formula 156 (red) is used in place of Formula 151 (gray) as the intermediate coat. Metal and coating repairs for water tanks can be made in the same manner as described for fuel tanks, but those for potable water tanks must be covered with an NSF-approved coating system, where these requirements prevail.

5.4.2 Exteriors of Steel Water Tanks. Exteriors of water tanks should be coated in the same manner as described in par. 5.3.2 for the exteriors of fuel tanks.

5.5 Other Steel Tanks. Steel tanks may contain waste water, chemicals, or other corrosive materials. Cathodic protection is also recommended for these tanks. Refer to par. 5.4.

5.5.1 Interiors of Other Steel Tanks. Interiors of steel tanks containing waste water, chemicals, or other corrosive liquids should be coated with a suitable corrosion-resistant lining (e.g., fiberglass-reinforced polyester) to protect the steel from corrosion. Since there are no Federal specifications for such products, specialty coating suppliers should be consulted about them.

5.5.2 Exteriors of Other Steel Tanks. Exteriors of steel tanks containing wastewater, chemicals, and other corrosive liquids should be coated with the system described for steel fuel tank exteriors in par. 5.2.2.

5.6 Steel Distribution Lines. Steel distribution lines containing water, fuel, or other liquids are coated to prevent loss of product from corrosion and contamination of soils and groundwater.

5.6.1 Steel Fuel Lines

5.6.1.1 Buried Steel Fuel Lines. Buried steel fuel lines must be coated and cathodically protected to meet Department of Transportation regulations and to provide their most economical protection.

a) The desired properties of coatings for buried, cathodically protected pipelines are:

- (1) Good electrical insulation
- (2) Good moisture resistance
- (3) Good adhesion
- (4) Resistance to cathodic disbonding
- (5) Resistance to damage during handling
- (6) Ease of repair

b) Coatings for piping to be buried should be applied in a shop under controlled conditions. Blasting with automatic equipment that recycles the abrasive should provide a high level of cleanliness (SSPC SP 5 or 10). Coatings that have been commonly used on buried piping include:

(1) Coal Tar Enamels - Coal tar enamels use different combinations of fiberglass and felt wraps to provide mechanical strength and thickness (1/8 inch or more). Their use has greatly declined because of environmental concerns about coal tar.

(2) Asphalt Mastics - Asphalt mastics are combinations of asphalt, sand, and other materials that are extruded over pipes at thicknesses up to 1/2 inch. They are quite moisture-resistant but lack resistance to both hydrocarbons and sunlight and, like coal tar enamels, are a health concern.

(3) Extruded Coatings - Extruded coatings typically have a 10 to 15 mil mastic base covered with a polyethylene or polypropylene outer jacket. They are sensitive to sunlight and must be covered if they are to be exposed to it for long periods of time.

(4) Fusion-Bonded Powder Coatings - Fusion-bonded powder coatings are usually applied by electrostatic spray to pre-heated pipe (400 to 500 degrees F) cleaned to a near-white surface (SSPC SP 10). The 10 to 30 mil coating is water-cooled before storage and subsequent use.

(5) Plastic Tapes - Polyethylene, vinyl, and coal tar tapes are available with different adhesives and thicknesses. Because they are relatively easily damaged, they are often installed with a secondary rock shield. Portable wrapping machines are also available for over-the-ditch application.

(6) Heat-Shrinkable Tapes - Heat-shrinkable tapes of polyolefin provide tight bonding to pipes. They are shrunk in place by heating at 300 to 400 degrees F. Their relatively high cost limits their use to special areas such as joints.

5.6.1.2 Immersed Steel Fuel Lines. Immersed pipes lines can be in fresh or salt water, near the surface where they are exposed to ultraviolet (UV) light or deep where UV light is not of concern. Further, some pipe lines are exposed to abrasion from particulates and debris in the water. A coating that has been successful in some applications is the three-coat epoxy system described for steel fuel tank interiors in par. 5.3.1. Vinyl coatings are effective where there is abrasion. The pipe lines can also be cathodically protected.

5.6.1.3 Aboveground Fuel Lines. Aboveground fuel lines can be coated much the same as fuel tank exteriors described in par. 5.3.2. A petrolatum paste/tape system has also been used very effectively in protecting fuel lines under piers. The system can be applied by hand over wire-brushed steel. It is very easy to repair when damaged.

5.6.2 Steel Water Distribution Lines. Steel water distribution lines should be coated as described for steel fuel distribution lines in pars. 5.6.1.1, 5.6.1.2, and 5.6.1.3, depending upon the environment, buried, immersed, or aboveground. Although buried steel water distribution lines do not present the same level of environmental hazard as do buried steel fuel lines, it is recommended that they be cathodically protected, as well as coated. For steel water distribution lines that are buried but not cathodically protected, use the three-coat epoxy-polyamide system described for steel fuel tank interiors in par. 5.3.1.

5.7 Communication Towers and Other Tall Structures. The military has thousands of communication towers of various sizes and configurations in many geographical and climatic regions. The tower designs and initial treatments of the steel construction materials often vary from site to site and within the same site. These variable factors often cause problems in obtaining cost-effective painting of the towers.

Many towers require either a painted pattern of alternate aviation orange and white markings for daytime visibility, or lighting (strobe for high towers). Requirements for marking and lighting are described in detail in Federal Aviation Administration (FAA) Advisory Circular 70/7460-1G. Compatibility of coatings can be determined as described in par. 5.6.2. The use of painted patterns over zinc-coated structures is a better choice over lighting for long-term use and operation

of towers. While lighting may be less expensive in initial construction and maintenance, an unprotected bare zinc surface will erode and require more expensive repairs than a bare surface. Further, some studies have shown that the lifetime of the zinc plus organic coating system is significantly greater than the sum of just the zinc coating and of an organic coating. While painting automatically brings maintenance problems, these are normally much less than those occurring to unpainted towers. The orange and white colors required by the FAA are available in aliphatic polyurethane, alkyd, and latex formulations.

5.7.1 New Towers. Today, new tower components are usually built with galvanized structural steel or steel thermally sprayed with zinc metal, if too large to be placed in a dipping tank.

5.7.1.1 New Galvanized Steel Towers. Galvanizing applications for steel tower components are typically heavy (e.g., 4 to 7 mils of zinc) and accomplished by hot dipping. Whether thermally sprayed or hot dipped, the zinc coating can provide several years of protection by itself. However, it will subsequently be necessary to apply a paint system to extend this corrosion protection, after the zinc is consumed. Because quality painting of towers after erection is both difficult and expensive, it is always best to apply organic coatings beforehand, preferably in a shop setting. Surface preparation and painting of tower components in a shop can be accomplished under controlled conditions to provide optimum protection of the metal. Shop cleaning of zinc-coated surfaces is normally limited to detergent washing to remove loose contaminants and/or solvent cleaning (SSPC SP 1) to remove grease or oil. Sometimes, a thin film of grease or oil is applied at the factory to protect galvanizing from corrosion during exterior storage. Also, new galvanizing is sometimes treated with chromate corrosion inhibitors for corrosion protection during storage. Such treatment should specifically be excluded in specifications for galvanized steel components to be coated.

Galvanized steel components are best protected with one coat each of epoxy-polyamide (e.g., MIL-P-24441 Formula 150) and aliphatic polyurethane (e.g., MIL-C-85285) coatings as described above. If a delay of over 4 days occurs before topcoating, the finish coat of polyurethane may not adhere because of the solvent resistance of the nearly fully cured epoxy coat. A thin (2-mil wet film thickness) film of the epoxy primer applied and allowed to cure to a tacky finish (e.g., 4 hours) will provide a suitable surface for the polyurethane finish coat. Epoxy and urethane coatings must have at least a 6-hour pot life for practical coating of towers in place. Oil-based paints (including oil/alkyds) are not

recommended because of the inherent incompatibility of oil-based paints with the alkaline surface of galvanizing. Premature failure by peeling is predictable.

A two-coat latex system (e.g., 1-1/2 mils dry film thickness each of MIL-P-28577 primer and MIL-P-28578 topcoat or SSPC PAINT 24) can also be used on galvanizing, but the protection and gloss and color retention may not be quite as good as with the epoxy/polyurethane system. The corrosivity of the exposure environment should be considered when choosing between the two systems.

5.7.1.2 New Thermally Sprayed Steel Towers. Thermally sprayed zinc is relatively porous and protects steel by cathodic protection. It should be sealed to provide maximum protection. Application of epoxy polyamide MIL-P-24441, Formula 150 thinned 50/50 has been very effective in sealing of thermally sprayed ship components. Where restrictions on the solvent (VOC) content prevail, sealing can be accomplished with a mist coat. Sealing should be followed with a full coat of Formula 150 applied at the usual 3-mil dry film thickness and a finish coat of aliphatic polyurethane (e.g., 2 mils dry film thickness of MIL-C-85285).

Some private companies have successfully coated thermally sprayed steel components with a single, heavy (e.g., 6 to 8 mils dry film thickness) coat of commercially available aluminum-filled epoxy mastic. Such a product is not covered by Government or industry specifications.

5.7.1.3 New Steel Towers. If new steel tower legs are not galvanized or thermally sprayed with a zinc coating, use of an inorganic zinc coating should be considered if the coating can be applied in the shop. A controlled shop environment can provide the proper conditions for obtaining a very corrosion-protective inorganic-zinc coating. These coatings (e.g., SSPC SP 5 surface preparation and MIL-P-24648, inorganic zinc) have been shown to provide long-term service with minimal maintenance requirements. If the coating must be applied in the field, an organic zinc-rich coating is probably preferred since they are more forgiving of surface preparation lapses and can be applied and cured over a wider range of environmental conditions. For either system, an intermediate coat of epoxy polyamide (e.g., MIL-P-24441, Formula 150) and a finish coat of aliphatic polyurethane (e.g., MIL-C-85285) can complete the system.

5.7.2 Existing Towers. It is best to repair damaged tower coatings on existing towers on a regular schedule before the damage becomes significant. To repair or topcoat existing coatings, it is necessary to know the generic type of the present coating. The same or another compatible coating must be used.

In some cases (e.g., with vinyl or chlorinated rubber coatings), another generic type coating may have to be used, because the old one is no longer permitted by many local environmental regulations.

Before contracting any tower painting, it is necessary to determine if any existing paint on the tower contains lead. Lead may be present as one or more components of alkyd paints or as pigmentation for the aviation orange color. Unless the absence of lead is definitely known, samples should be taken and submitted to a laboratory for analysis. Refer to NFGS-13283 or CEGS 02090 for information on removal, containment, and disposal of lead-containing paint. If the generic type of the existing finish coat is not known, a compatible coating may be selected by merely determining its solvent solubility. To do this, soak a cloth in methyl ethyl ketone or acetone, rub it against the existing paint, and visually check for pickup of paint. The paint is classified as "solvent soluble" if paint is picked up, and as "solvent insoluble" if not.

The common practice of applying paint by glove is not recommended. It produces neither a continuous nor a uniformly thick paint film. Roller application is also not recommended because of difficulties in coating irregular surfaces. Spray application by portable equipment produces the most attractive finish but generally produces much overspray. Electrostatic spraying can eliminate overspray, if it is available on high platforms. Spray cans can provide a quick cosmetic touch-up for small damaged areas. Brushing is generally the most practical application method to coat sharp edges, crevices, and corners. It also can produce a relatively uniform, continuous film.

5.7.2.1 Towers With Only Cosmetic Coating Defects. Maintenance painting to correct fading, discoloration, or limited intercoat peeling should be undertaken when the existing aviation orange on the upper portion of the tower fails to meet the requirement of the color tolerance chart of the FAA (refer to Advisory Circular 70/7460-1G). Whatever the construction material, the only surface preparation that is required is removal of loose contaminants with a bristle brush or by washing. One or two coats of acrylic latex finish (e.g., TT-E-2784), as required for complete hiding of the existing paint, should be applied to the cleaned surfaces. Normally, weathered exterior coatings are sufficiently textured for good adhesion and general compatibility of latex topcoats. However, severe chalking of the old coating may present an adhesion problem for latex coatings.

5.7.2.2 Zinc-Coated Steel Tower Components With Deteriorated Organic Coatings. Zinc-coated steel (either galvanized or thermally sprayed) with damaged organic coatings should be scrubbed with a bristle brush to clean the exposed metal surface and remove loose coatings. The coatings should also be lightly sanded, if necessary, to feather edge the damaged areas. If the old paint is oil, alkyd, latex, vinyl or solvent soluble, apply one coat each of latex primer and finish to the exposed zinc coating and overlay it 1 inch onto the surrounding tight coating. If the repaired area matches the intact paint, it will not be necessary to topcoat the undamaged areas.

If the existing finish coat is polyurethane, epoxy, or solvent insoluble, apply one coat of epoxy primer and one coat of aliphatic urethane finish to damaged areas. Again, if the match is good, topcoating of undamaged areas will be unnecessary.

If an inorganic zinc-primed steel component has suffered topcoat damage, it should be repaired with the original topcoat system. If the inorganic zinc primer itself is damaged, it should be repaired with a zinc-rich epoxy primer (e.g., MIL-P-24441, Formula 159) and then given an epoxy intermediate coat and an aliphatic polyurethane finish coat. Sometimes, corrosion of the galvanizing has been so severe that underlying steel is exposed. Such areas should be treated as described below for steel tower components.

5.7.2.3 Steel Tower Components (With No Zinc Coating) With Damaged Organic Coating. Steel components of towers that have never received a zinc coating and currently have damaged coatings should be hand (SSPC SP 2) or power tool (SSPC SP 3 or 11) cleaned to remove rust and loose paint. The preferred method of surface preparation is SSPC SP 11. This method not only removes all visible rust but also produces a roughened surface so that it is considered comparable to SSPC SP 6. Powered needle guns and grinders with flexible wheels and disks can produce the SSPC SP 11 surface. The steel should be cleaned and primed the same day, before flash rusting occurs.

If the old paint is oil, alkyd, latex, vinyl or solvent soluble, apply two coats of alkyd primer to the exposed steel to a total of 3 mils dry film thickness and overlay it 1 inch onto the surrounding tight coating. A primer with raw linseed oil (e.g., SSPC PAINT 25) will penetrate the surface better but dry relatively slowly. A totally alkyd primer (e.g., TT-P-645) will dry faster but may not penetrate the surface as well. After priming, apply two alkyd or silicone alkyd (e.g., MIL-E-24635, Enamel, Silicone Alkyd Copolymer (Metric)) finish coats at the same thickness. Two additional coats of primer followed by one or more latex finish coats can be used instead of the alkyd

finish coats, if the alkyd finish coats are unavailable because of environmental regulations. If the repaired area matches the intact paint, it will not be necessary to topcoat the undamaged areas.

If the existing finish coat is urethane, epoxy, or solvent insoluble, apply two coats of epoxy primer and one coat of aliphatic urethane finish. Again, if the match is good, topcoating of undamaged areas will be unnecessary.

5.7.3 Galvanized Steel Guy Lines for Towers. Tall towers are usually supported with galvanized steel stranded guy lines. These are frequently coated with a commercial preservative grease, as they are installed. These greases or pastes are most frequently petroleum or drying oil products. Care should be taken not to contaminate the guys before they are coated. Some equipment is available for applying the grease after installation of guys. Equipment for remote application is described in NCEL Techdata Sheet 76-04. Galvanized steel anchor support systems securing guys in place can also be protected by preservative greases.

5.8 Waterfront Structures. The coating of steel waterfront structures is described in NFGS-09967, Coating of Steel Waterfront Structures. Coating systems are best applied in a shop under controlled conditions. Systems which have provided good protection have included abrasively blasting to a near-white condition (SSPC SP 10) and application of one of the following coating systems:

a) Epoxy polyamide system - e.g., three coats of MIL-P-24441 starting with Formula 150 primer (each 3 mils dry film thickness).

b) Coal tar epoxy-polyamide System - e.g., two coats of SSPC PAINT 16 (each 8 mils dry film thickness).

Repainting or spot repairing coatings in or below tidal areas is a real problem. Quick-drying lacquers that can dry between tidal changes are not permitted at many locations because of VOC restrictions. One approach to resolve the problem is to use a cofferdam to apply suitable materials such as MIL-P-24441 or SSPC PAINT 16 that can cure underwater. Another approach is to use viscous splash-zone compounds that are applied manually or thinner epoxy materials that can be applied underwater by brush, roller, or pads.

5.9 Hydraulic Structures and Appurtenant Works. Coating of hydraulic structures and associated pipe lines and equipment is described in CWGS 09940, Painting: Hydraulic Structures and

Appurtenant Works. Cathodic protection of gates is described in CWGS 16643. Coatings for use on locks and dams must have good abrasion resistance in addition to providing good corrosion control. Vinyl systems have worked well for many years.

5.10 Factory Finished Metal Siding. Factory-finishing of steel, galvanized steel, or aluminum siding is usually accomplished by specialized procedures (e.g., coil coating) using commercial products. It is best to consult the manufacturer of the siding for recommended coating repair methods.

5.11 Chain Link Fences. Chain link fences are usually made of galvanized steel (refer to NFGS-02821, Chain Link Fences and Gates, or CECS 02831, Fence, Chain Link). Occasionally, they are made of vinyl-clad steel or aluminum-coated steel. As the protective metals or vinyl corrode or erode away, they may need coating to further protect them and/or to restore an attractive finish. The fencing must be washed with a detergent solution to remove loose contaminants before coating with a long-nap roller or electrostatic spray equipment. The coating system should be composed of two coats of acrylic latex (e.g., TT-E-2784) or one coat each of epoxy-polyamide (e.g., MIL-P-24441, Formula 150) and aliphatic polyurethane (MIL-C-85285).

5.12 Hot Steel Surfaces. Mufflers, stacks, and other hot steel surfaces are not protected by conventional coatings, because they are quickly burned away. Even thin fused aluminum coatings such as TT-P-28 provide only limited protection, provided that they are fused properly. (These coatings must be exposed to at least 400 degrees F for a short time for fusion to take place.) Such steel surfaces are better protected by thermally sprayed zinc (withstand up to 700 degrees F) or aluminum (withstand up to 1600 degrees F or higher when sealed) after blasting to a white metal finish (SSPC SP 5). Thermal spraying of aluminum is described in DOD-STD-2138(SH), Metal Spray Coatings for Corrosion Protection Aboard Naval Surface Ships (Metric).

5.13 Concrete Fuel Tanks. The DOD has many concrete fuel tanks (mostly underground) that were built during World War II. They have been lined with the cloth-reinforced latex coating system described in NFGS-09980, Interior Linings for Concrete Storage Tanks (for Petroleum Fuels), epoxy systems, and other systems. Cloth-latex reinforced systems have been found to work as well as any. However, they may not work well over concrete that is contaminated with oil. Oil contamination is difficult to remove and latex coatings do not bond well on this surface.

5.14 Concrete Swimming Pools. Concrete swimming pools require periodic painting to keep them watertight and attractive. Even fiberglass-reinforced plastic pools may require refinishing to restore them to an acceptable appearance should they fade or chalk significantly. Chlorinated rubber coatings (e.g., TT-P-95, Type I) have been used effectively for many years for lining pools. Although these coatings are high in VOCs (solvent content), they have received a temporary exemption for coating concrete pools in most locations with VOC limitations. Epoxy coatings perform well on interior concrete pools, but some of them chalk to such an extent, even underwater, that the water is clouded in exterior pools. Waterborne pool coatings have not proven to be durable.

a) Exterior pools are usually coated in the spring before the swimming season when the temperature is between 50 and 80 degrees F. New concrete pools should be allowed to cure at least 2 months before painting. The first step in preparing concrete pools for painting is to make necessary repairs:

- (1) Remove loose concrete
- (2) Repair small cracks and holes
- (3) Repair large cracks and spalls

b) Repair small cracks and holes with a non-shrinking patching compound. Cracks greater than 1/2 inch and spalls should be repaired with cementitious material (e.g., a mix containing two parts of clean, hard, sharp sand to one part of Portland cement). The repair area should be thoroughly wetted and enough water added to the mix to make a heavy paste.

c) After repairs have been made, any efflorescence or laitance on the surface of the concrete should be removed by brushing with a dry bristle brush, treating with 5 to 10 percent muriatic (hydrochloric) acid, and rinsing with clear water. Mildew should be removed as described in par. 5.18, and body oils should be removed with trisodium phosphate or other detergent. Any deteriorated old paint should be removed by wire brushing or careful light abrasive blasting.

d) Application of chlorinated rubber paint should occur in two coats to completely dry surfaces. The first coat is best applied by brush to fill the concrete pores, but the second can be applied by roller or spray. A minimum of 24 hours should occur between coats to ensure complete evaporation of solvent from the first coat. Painting of individual walls should continue until completion to avoid lap marks where the work was interrupted. Because the coating dries very fast, it may be

necessary to paint walls in the shade or at night during hot weather. A minimum of 7 days should elapse between painting of the pool and filling it with water.

5.15 Concrete Catchment Basins. Concrete catchments are used by some activities with limited water supplies to collect rainwater for both industrial and domestic use. The catchments are usually sealed with a coating material and the joints caulked with a flexible material to minimize water losses. Both of these materials must be approved for potable water use, if the collected water is to be for domestic use.

Thick cementitious coatings have been used satisfactorily for many years to seal catchments. The Government of Bermuda requires catchments to be free from unsightly mildew. This is often a limiting factor there for cementitious coatings, since their textured surfaces become mildew-defaced much sooner than smooth coatings. Treatment with hypochlorite solution, as described in par. 4.17, can restore mildew-defaced catchments to a cosmetically pleasing appearance.

Acrylic latex elastomeric coatings have been found to perform very well on concrete catchments. They provide excellent resistance to water migration, weathering, and mildew. A primer is usually required for good adhesion.

5.16 Chemically Resistant Finishes for Concrete Floors. Chemically resistant urethane coatings (resistant to fuels and hydraulic fluids) are sometimes used to impart improved lighting to work areas such as under aircraft. Because of the smoothness of these coatings, skid resistance is usually imparted by sprinkling granules into the wet coating. Such a system is described in A-A-50542, Coating System: Reflective, Slip-Resistant, Chemical-Resistant Urethane for Maintenance Facility Floors. A commitment to maintenance is essential when deciding to coat a concrete floor. Cleaning and repair will be needed on a frequent and regular basis to maintain the reflectivity and appearance of the floors.

Chemical resistance may also be required for floors where chemicals or hazardous waste is stored to permit rapid neutralization and removal without contaminating other stored materials. The coating should be chosen to be resistant to the stored materials, so that it is best to consult the activity industrial hygienist. Chemical-curing polyurethane or epoxy systems as described for fuel tank interiors in par. 4.2.1 are good candidates.

5.17 Slip-Resistant Floors. A slip-resistant coating is often applied as a finish for other coating systems to prevent accidental slipping. The resistance is imparted by sprinkling granules in the wet coating. MIL-E-24635 is used for alkyd systems and MIL-C-24667, Coating System, Non-Skid, for Roll or Spray Application (Metric) for epoxy systems. The MIL-C-24667 may also be used on alkyd systems where MIL-E-24635 may exceed local VOC limitations.

5.18 Fouling-Resistant Coatings. Antifouling coatings are often used over a coating system that imparts corrosion resistance to ships or other structures to be immersed in sea water. A toxic material, usually copper ion, is slowly leached into the sea water to deter attachment and growth of biological fouling organisms. MIL-P-24647, Paint System, Anticorrosive and Antifouling, Ship Hull is normally recommended for this purpose. It has a large list of qualified products. Such a copper-containing product should not be used on an aluminum boat, because direct contact of a copper product with aluminum will result in accelerated galvanic corrosion. Commercial organo-tin antifouling paints are permitted on aluminum boats. There are restrictions on their use on large Navy ships.

5.19 Mildew-Resistant Coatings. Mildew growth on painted or unpainted surfaces of buildings can cause unsightly defacements, especially at tropical and subtropical locations. This occurs on interior and exterior surfaces of steel, concrete/masonry, asbestos-cement, or wood. Mildew can also damage delicate communications and utilities equipment. In addition serious bronchial problems may be associated with living in quarters contaminated with mildew-covered surfaces. The different species of microorganisms usually present in mildew growths include molds, yeast, algae, and bacteria. These same organisms are found on mildew-defaced surfaces throughout the world. The darkly pigmented organisms are most conspicuous and contribute to most of the defacement.

5.19.1 Factors Affecting Mildew Growth. Factors that affect likelihood of mildew growth include:

a) Weather - Higher temperatures and dampness promote growth, and light inhibits it.

b) Building Design - Rough surfaces assist pickup of spores and dirt, roof overhang keeps wall surfaces damp longer, poor drainage, and porous substrates such as wood retain moisture; alkalinity on concrete surfaces inhibits growth; and air exchange, temperature, and humidity may control growth.

c) Paint - Textured, tacky, and peeling paint pick up and retain spores and dirt; incompletely removed mildew may rapidly reinfest new paint; drying oils in paints may be used as nutrients. Mildewcides in paints can control the growth of mildew organisms.

5.19.2 Use of Mildewcides in Paints. Mercury-containing mildewcide additives were used very successfully in paints for many years to control mildew growth. Only a small amount of the mercury compound leaching from the paint was necessary to kill microorganisms. Unfortunately, it also contaminated the environment with toxic material. Thus, mercury-containing mildewcides are no longer used in paints. EPA has approved alternative nonmercurial compounds for use as paint mildewcides. Some of these products, however, have not proven to be effective in retarding mildew growth.

5.19.3 Removal of Mildew. Mildew must be killed before repainting a mildewed surface to obtain control of the mildew. If spores are just painted over, the mildew will quickly grow and become unsightly. When a surface is to be cleaned for repainting, scrub with a solution of 2/3 cup of trisodium phosphate, 1 liquid ounce of household detergent, 1 quart of 5-1/4 percent sodium hypochlorite (available as household bleach), and 3 quarts of warm water. Use rubber gloves with this caustic solution and rinse it from the surface with water after scrubbing. It will degrade alkyd and other oil-based coatings, but this will be no problem, if the surface is to be repainted. An alternate procedure is to remove all the visible mildew by waterblasting at about 700 pounds per square inch (psi) and kill the rest by rinsing with a solution of 1 quart of 5-1/4 percent sodium hypochlorite and 3 quarts of warm water.

If a painted surface is to be merely cleaned without repainting, apply the scrubbing solution without the trisodium phosphate to avoid damage to the paint. Apply it first to a small test area to see if the hypochlorite bleaches the paint. If it does, merely clean with detergent and water.

Mildew on field structures can be distinguished from dirt with bleach. Common household hypochlorite bleach will cause mildew, but not dirt, to whiten.

5.20 Pavement Markings. Asphalt and concrete airfield and road pavements on military bases are generally striped with paint to show center and sidelines, as well as other information. These markings are described in NFGS-02761, Pavement Markings, and CEGS 02580, Joint Sealing in Concrete Pavements for Roads and Airfields.

5.20.1 Painted Markings. Military airfields and roadways have been successfully marked with alkyd paints for many years. Chlorinated rubber was added to the alkyd resin to obtain faster drying times. More recently, environmental restrictions on total paint solvent have in many geographical locations eliminated or restricted the use of these marking paints. Thus, most pavements at military activities are marked with latex paints today.

Yellow marking paints constitute a possible safety and environmental problem. Historically, a lead chromate pigment has been used to impart this color because it is relatively light, stable, and inexpensive. Lead pigments were recently restricted from use in consumer paints because of concerns that dust from weathering paints might be ingested by children. More recently, concern has been expressed about the hazards of chromate pigments. New regulations impose restrictions on the removal of old paints containing lead and chromium because of possible adverse health effects the dust produced may have on workers or residents in the area. Also, residues of lead and chromate-containing paints may constitute hazardous waste which must be specially handled, stored, and disposed of properly. This has led to the virtual elimination of lead and chromium constituents in paint. The State of California Department of Transportation and other state highway departments have had good success with yellow striping paints with organic pigments that do not constitute a health or environmental hazard.

5.20.1.1 Specifications for Marking Paints. Currently, there are five federal specifications for marking paints. Specification TT-P-85, Paint, Traffic and Airfield Marking, Solvent Base is for a solvent-based traffic and airfield marking paint, available in white and yellow. Alkyd formulations have generally been used, even though no specific generic type is required. Paints of this specification are high in VOCs and so cannot be used in areas where such paints are prohibited (urban areas with air pollution). Water-based marking paints conforming to TT-P-1952 are used in such areas, as well as in areas without such restrictions.

a) Specification TT-P-87, Paint: Traffic, Premixed, Reflectorized is for a premixed, solvent-based, reflectorized traffic paint, available in white and yellow. Low index of refraction (road) beads are premixed with the paint before packaging. The embedded beads are reported to be exposed as vehicular traffic erodes away the marking. They are not suitable for use on airfields because of the low index of refraction beads.

b) Specification TT-P-110, Paint, Traffic, Black (Nonreflectorized) is for a solvent-based, black, nonreflectorized traffic paint generally made with alkyd binders. It is used mostly to outline white or yellow markings to make them stand out or to obliterate old markings on asphalt pavements. Such paints are not VOC-conforming, and there is no specification for a black water-based marking paint.

c) Specification TT-P-115, Paint, Traffic (Highway, White and Yellow) is for a solvent-based traffic paint, available in white and yellow. Once, this specification called for alkyd formulations for conventional-dry paints and chlorinated rubber-alkyd formulations for fast dry types. This is no longer the case. Because of VOC and safety concerns described below, this specification is no longer recommended.

d) Specification TT-P-1952, Paint, Traffic and Airfield Marking, Water Emulsion Base is for a water-based traffic and marking paint, available in white or yellow. Currently, there are no environmental restrictions on its use. Acrylic and polyvinyl acetate resins are most frequently used in paints conforming to this specification.

e) Specifications TT-P-85, TT-P-115, and TT-P-1952 are formulated to permit glass beads to be dropped into the wet paint immediately after spray application to provide night retroreflectivity. Coarse beads are evenly dropped into wet TT-P-87 paint to impart immediate retroreflectivity.

5.20.1.2 Specification for Reflective Glass Beads.

Specification TT-B-1325, Beads (Glass Spheres) Retro-Reflective is for beads (glass spheres) to impart retroreflectivity to painted markings. Lights from a plane or car are reflected back to the eyes of the pilot or driver. Type I (low index of refraction) is intended for use on roads. It is available in Gradations A (coarse-drop on), B (fine-premix), and C (fine-drop on). Type II (medium index of refraction), Gradation A (coarse-drop on) is not commercially available today. Type III (high index of refraction) is intended for use on airfield pavements.

5.20.1.3 Application of Painted Markings. Although the five above marking paint specifications are different from each other, each is applied at about the same thickness. Some achieve this by specifying a 15-mil wet film thickness, which results in a dry film thickness of half that, since they contain 50 percent solids by volume. Others specify a spreading rate of 100 to 110 square feet per gallon. The water-based paint of specification TT-P-1952 must be applied at temperatures at or above 45 degrees F. The other products, which are solvent based, can be applied at even lower temperatures. Surfaces to be marked must be well

prepared for painting, free from dirt, oil and grease, other surface contaminants, and from loose, peeling, or poorly bonded paint. If removing lead-containing traffic marking paints (e.g., some yellows), environmental and worker safety regulations apply. Refer to Section 3 for more information.

When airfield markings are to be reflectorized, TT-B-1325, Type III beads are applied immediately after spray application at the rate of 10 pounds per gallon of paint. Roadways are reflectorized with TT-B-1325, Type I beads applied at the rate of 6 pounds per gallon of paint. In both cases, any more beads would have insufficient paint available to be retained. Type I beads have a much lower specific gravity than Type III beads.

For marking pavements, striping machines (specially equipped trucks) are used. They have tanks that hold large quantities of paints and beads. Striping machines for airfields have arrays of multiple spray gun and bead dispensers and necessary power and support equipment to apply long painted lines 3 feet wide. The spray guns and dispensers are adjusted to give a uniform paint thickness and bead density across the entire width of the marking.

5.20.1.4 Inspection of Marking Operation. Inspection procedures for monitoring contracts for striping airfields are distinctly different from other painting inspections. They are presented below in the general order in which they might be used.

a) Procedure 1: General Appearance of Paint and Beads. Visual examination of paint in the can and beads is done to check for any apparent deficiencies. Products with apparent discrepancies should receive a laboratory analysis or be replaced. Product labels should also be checked to verify that they are the ones specified. Paints must be homogeneous in color and consistency. They should be stirred to assure that they are free of settling, skinning, caking, strings, and foreign bodies and have a viscosity suitable for spraying. Method 3011.2 of FED-STD-141, Paint, Varnish, Lacquer, and Related Materials: Methods of Inspection, Sampling, and Testing describes precisely how to check for "Condition in Container." Beads must be clean, dry, free flowing, and free of air intrusions. They should be only a few extremely large, small, or out-of-round beads. Type I beads have a pure white color; Type III beads have a brownish cast.

b) Procedure 2: Sampling of Paint and Beads. Paints and beads may be sampled for immediate analysis or merely taken for later use, if problems arise later. In any event, it is necessary to procure samples that authentically represent the material to be applied to the pavements. Incompletely cleaned

paint tanks may contain significant amounts of water or another batch of paint. Incompletely emptied bead tanks may contain beads of another type. Paint and bead samples should be taken from drums or sacks to determine whether the supplier's material meets all requirements. Excessive mixing of latex marking paints should be avoided prior to testing, because their wetting agents cause them to froth when heavily mixed, and this may result in testing errors. Excessive stirring of beads may cause smaller or lighter density beads to migrate to the bottom of the container. Full sampling and inspection procedures are presented in Method 1031 of FED-STD-141.

c) Procedure 3: Percent by Weight of Paint Total Solids and Pigment. These tests are run to provide information on the paint composition and a quick check for its conformance to specification. These tests are done with the same sample using ASTM D 2369, Volatile Content of Coatings and ASTM D 3723, Pigment Content of Water-Emulsion Paints by Low-Temperature Ashing. By using the relationships percent total solids equals percent binder plus percent pigment and percent total solids equals 100 minus percent volatile, results of the two referenced test procedures can provide data on any of these components (e.g., solvent, binder, pigment, and total solids). Testing should be done in triplicate to indicate repeatability. The percent by weight of total solids (or the percent volatile) of latex paints is determined by measuring the loss of weight after the solvent has been evaporated off by heating the sample at 110 degrees C for 2 hours. The percent by weight of pigment is determined by measuring the weight after further heating of the samples for 1 hour at 450 degrees C to burn up the organic binder.

d) Procedure 4: Specific Gravity of Paints. In ASTM D 1475, Density of Paint, Varnish, Lacquer, and Related Products, a metal cup of precisely selected volume is weighed first empty and then filled with paint until it is forced out a hole in the cap. The additional weight is a direct measure of specific gravity.

e) Procedure 5: Paint Binder Identification. ASTM D 2621, Infrared Identification of Vehicle Solids From Solvent-Reducible Paints can readily identify the generic type of marking paints as 100 percent acrylic. Only a small sample of the wet or dry (e.g., 1 square inch) paint is necessary.

f) Procedure 6: Specific Gravity of Beads. The specific gravity of beads can easily be determined by field personnel with access to an inexpensive balance following the procedure of par. 4.3.5 of TT-B-1325. A sample of dried and weighed beads (about 60 g) is placed in a glass graduated

cylinder containing 50 ml of xylene, and the resultant increase in volume is noted. The specific gravity is then determined by simple division:

$$\text{Specific Gravity} = \frac{\text{Weight of Sample (about 60 g)}}{\text{New Total Volume} - 50 \text{ ml}}$$

g) Procedure 7: Index of Refraction of Beads. The index of refraction of glass beads can be determined by immersing them in standard liquids with different refractive indexes and observing whether the beads blend into the liquid. Blending occurs when the liquid has a higher refractive index than do the beads. Indentations of a ceramic spot plate can be conveniently used for holding the beads and liquid. Run this test when substitution of TT-B-1325, Type I beads for Type III beads is suspected. This is normally suspected from a low specific gravity value in Procedure 6.

h) Procedure 8: Preparation of Drawdowns for Determining Retroreflectivity. Drawdown specimens are prepared using a metal drawdown bar as described in ASTM D 823, Producing Films of Uniform Thickness of Paint, Varnish, and Related Products on Test Panels. A paint film of 16 mil or other wet film thickness is screeded onto a the white surface of a black and white chart by drawing it across the paper in front of a bar of proper clearance. Immediately after this action, beads are manually sprinkled into the wet paint. After drying, the drawdowns are measured with a retroreflectometer. The instrument can be held in either direction, since the application procedure does not have a directional effect.

i) Procedure 9: Surface Preparation. Inspection of pavement surfaces prepared for marking with paint is basically determining whether the surface is clean enough and sound enough to permit tight bonding of the paint. Cleaning of concrete for painting is described in ASTM D 4258, Surface Cleaning Concrete for Coating. Of the several procedures described for cleaning, high-pressure water blasting with truck-mounted equipment is almost always the procedure selected for rubber and paint removal. Washing with an aqueous detergent solution may be necessary to remove oil, grease, and tightly bonded dirt. The extent of paint removal should be verified visually. If only loose paint is to be removed prior to restriping, the remaining paint can be checked with a dull putty knife to determine whether only sound paint remains. After a build-up of five coats (a dry film thickness of 37 mils), the film becomes rather inflexible and subject to cracking, and the skid resistance significantly reduced. Thus, complete removal of the old marking is recommended at this time. From a standpoint of eliminating the

hazard of hydroplaning on wet pavements, it is not necessary to remove 100 percent of the rubber build-up on runways. From a standpoint of surface preparation for marking pavements, however, virtually complete removal is more important. While one contractor was observed to be able to achieve 100 percent removal with his equipment without apparent difficulty, others could not do so using their equipment without considerable expense and damage to the pavement. It may be necessary to settle for less than 100 percent (e.g., 90 percent) removal to permit competitive bidding until the technology for 100 percent removal becomes widely available.

j) Procedure 10: Check of Application Equipment. Paint spray guns and bead dispensers should be checked to determine that they are properly metered and functioning. Metering can be checked individually, directing paint or beads into a container for collection. To check for proper application and overlap of paint patterns (fans) from spray guns and beads from dispensers, apply a small area of paint and beads onto roofing paper or other disposable material taped to the pavement.

k) Procedure 11: Monitoring of Marking Operation. The prevailing conditions should be recorded before starting to apply markings. This includes temperature; dew point, if solvent-based paints are used; rain or prospects of rain; wind; type of equipment used; and any unusual conditions. Wind can cause overspray of the paint onto the beads to significantly reduce their retroreflectivity. General weather forecasts are normally available from operations offices. A variety of thermometers are available for measuring temperature, and inexpensive sling psychrometers are usually used for measuring humidity and dew point. Photography can be an excellent method of recording conditions. Solvent-based paints should not be applied unless the temperature is at least 5 degrees above the dew point and above 40 degrees F and rising or if rain is expected within an hour. In addition, water-based paints should not be applied when the temperature is below 45 degrees F. Paint should be applied when the wind is over 5 mph, unless it can be shown that the marking can be applied properly with the existing equipment. None should ever be applied when the wind is over 10 mph. The marking should be continuous (no underlap at all or overlap of adjacent spray patterns greater than 1/4 inch) with a constant color that matches the standard or submittal, and free from wind-blown dust and dirt. The edges of the marking should be relatively sharp and straight. The marking should be touched with a finger to determine if complete drying has occurred within the time specified for the paint. Dried paints should be probed with a dull putty knife to determine that they are well bonded.

The beads should be relatively uniformly spread across and along the marking. At least 25 beads should be found in every square inch, to obtain desired level of retroreflectivity.

l) Procedure 12: Wet Film Thickness of Stripes. Wet film thickness can easily be determined using the procedure of ASTM D 1212, Measurement of Wet Film Thickness of Organic Coatings. A metal or plastic gage with calibrated notches cut into each of four faces is used for this purpose. The face calibrated for the desired wet film thickness is pushed squarely into a freshly painted surface and withdrawn. The wet film thickness of the marking is equal to the depth of the deepest notch with paint on it. A sample of wet paint without beads must be applied to a rigid test panel by the striping machine in a test run. It is best made on roofing paper or other disposable material to avoid contamination of a pavement. Obviously, a series of plates secured across the width of 3-foot-wide stripes must be used for each test run to determine localized application rates.

m) Procedure 13: Dry Film Thickness of Paint Film. The dry film thickness of a paint film can be estimated from the wet film thickness by the relationship:

$$\text{Dry Film Thickness} = \frac{\text{Wet Film Thickness} \times \text{Percent Solids by Volume}}{100}$$

Dry film thickness of paint applications can be determined quite precisely using a magnetic gage as described in ASTM D 1186, Nondestructive Measurement of Dry Film Thickness of Nonmagnetic Coatings Applied to a Ferrous Base. A ferrous plate is coated with marking paint by the striping machine but no beads are applied. The paint is allowed to cure completely before its dry film thickness is determined by magnetic gage. Again, a series of test plates must be used on runway stripes to determine thicknesses across the stripe. Tin-plated steel panels used in paint elongation testing by ASTM D 522, Mandrel Bend Test of Attached Organic Coatings are convenient to use for this purpose.

n) Procedure 14: Spreading Rate of Paint. After the wet film thickness of a marking has been made, as described above, the spreading rate of the paint can be estimated by the relationship:

$$\text{Spreading Rate of Wet Paint in Square Feet/Gallon} = \frac{1600}{\text{Wet Film Thickness in Mils}}$$

From a practical standpoint, it is easier to specify a paint's wet film thickness than its spreading rate.

o) Procedure 15: Retroreflectivity of Pavement Markings. Measure the retroreflectivity of airfield markings for conformance to contract specification using a Mirolux 12 or Erickson instrument. In addition to following the instrument manufacturer's instructions, these precautions should be taken:

- (1) Keep an extra fully charged battery available.
- (2) Frequently check instrument calibration.
- (3) Systematically make five measurements across stripes at each test site rather than in the direction of or opposite to application to avoid directional effects.
- (4) Select numerous random test areas to obtain representative measurements.

Use of a portable computer while making retroreflectivity measurements can greatly accelerate the procedure. This is especially important on busy runways with limited access time. Typically, a two-person team has a driver who stays in the vehicle keeping radio contact with the tower, recording data into the computer and driving to the different test locations. The other team member measures retroreflectivities and calls out the data to the driver.

5.20.2 Alternative Markings. A variety of tapes, buttons, and reflectorized squares have been successfully used to mark roadways. Tapes have been used at military installations to provide temporary markings. They may be damaged by turning wheels of heavy trucks. None of these alternative marking materials are recommended for use on runways because of concern for foreign object damage.

5.21 Wooden Floors. The surface preparation (scraping and sanding) and coating of wooden floors is described in NFGS-09900 and CEGS 09900. These finishes include stains and alkyd and moisture-curing coating systems. For hardwood floors for gymnasium-type use, a selection can be made from the MFMA Heavy Duty and Gymnasium Finishes for Maple, Beech and Birch Finishes. The products addressed include sealers, heavy-duty finishes, gymnasium-type finishes, moisture-cured urethane finishes, and water-based finishes. The individual suppliers should be contacted for special applications such as handball and racquetball.

Section 6: SURFACE PREPARATION

6.1 Introduction. Surface preparation is the single most important factor in determining coating durability. Available data and experience indicate that in most situations, money spent for a clean, well-prepared surface reduces life-cycle costs. A proper surface preparation:

a) Removes surface contaminants (e.g., salts and chalk) and deteriorated substrate surface layers (e.g., rust and sunlight-degraded wood) which hinder coating adhesion and;

b) Produces a surface profile (texture) that promotes tight adhesion of the primer to the substrate.

6.1.1 Selection Factors. Factors which should be considered in selecting the general type and degree of surface preparation are:

a) Type of the substrate

b) Condition of the surface to be painted

c) Type of exposure

d) Desired life of the structure, as some procedures are much more expensive than others

e) Coating to be applied

f) Environmental, time, and economical constraints

6.1.2 Specification Procedure. A performance-based requirement for surface preparation, rather than a prescriptive requirement, is recommended for contract use. That is, it is usually better to describe the characteristics of the cleaned surface (e.g., profile and degree of chalk removal) than to specify the specific materials and procedures to be used. Often the general type of surface preparation (washing, blasting, etc.) is specified, because of job or other constraints, along with requirements for characteristics of the cleaned surface. In this way, the specifier allows the contractor to select the specific equipment, materials and procedures to get the job done and avoids putting contradictory requirements into the job specification.

6.1.3 Section Organization. This section is organized into: discussions of repair procedures usually done in conjunction with a painting contract and prior to painting; specific

recommendations for surface preparation procedures and standards for specific substrates; recommendations for coating removal; and general background information on surface preparation methods. Surface preparation methods are summarized in Table 6.

6.2 Repair of Surfaces. All surfaces should be in good condition before recoating. If repairs are not made prior to painting, premature failure of the new paint is likely. Rotten wood, broken siding, and other deteriorated substrates must be replaced or repaired prior to maintenance painting. Water-associated problems, such as deteriorated roofs and nonfunctioning drainage systems, must be repaired prior to coating. Interior moist spaces, such as bathrooms and showers must be properly vented. Cracks, holes, and other defects should also be repaired.

Areas in need of repair can sometimes be identified by their association with localized paint failures. For example, localized peeling paint confined to a wall external to a bathroom may be due to inadequate venting of the bathroom. Refer to Section 11 for more examples.

6.2.1 Joints, Cracks, Holes, or Other Surface Defects. Caulks and sealants are used to fill joints and cracks in wood, metal and, in some cases, in concrete and masonry. Putty is used to fill holes in wood. Glazing is used to cushion glass in window sashes. Specially formulated Portland cement materials are available for use in cracks and over spalled areas in concrete. Some of these contain organic polymers to improve adhesion and flexibility. Other materials are available to repair large areas of interior plaster (patching plaster), to repair cracks and small holes in wallboard (spackle), to fill joints between wallboards (joint cement), and to repair mortar. Before application of these repair materials, surfaces should be clean, dry, free of loose material, and primed according to the written instructions of the material manufacturer.

Caulking and sealant compounds are resin based viscous materials. These compounds tend to dry on the surface but stay soft and tacky underneath. Sealants have application properties similar to caulking materials but tend to be more flexible and have greater extendibility than caulks. Sealants are often considered to be more durable than caulks and may also be more expensive. Commonly available generic types of caulks and sealants include oil-based, butyl rubber, acrylic latex, silicone, polysulfide, and polyurethane. The oil-based and butyl-rubber types are continually oxidized by exposure to sunlight and become brittle on aging. Thus, their service life is limited. Acrylic-latex and silicone caulks tend to be more

stable and have longer service lives. Applications are usually made with a caulking gun. However, some of these materials may also be available as putties or in preformed extruded beads that can be pressed in place.

Putty and glazing compounds are supplied in bulk and applied with a putty knife. Putties are not flexible and thus should not be used for joints and crevices. They dry to form a harder surface than caulking compounds. Glazing compounds set firmly, but not hard, and thus retain some flexibility. Rigid paints, such as oil/alkyds, will crack when used over flexible caulking, sealing, and glazing compounds and should not be used. Acrylic-latex paints, such as TT-P-19, Paint, Latex (Acrylic Emulsion, Exterior Wood and Masonry) are a better choice.

6.2.2 Cementitious Surfaces. Epoxy resin systems for concrete repair are described in MIL-E-29245, Epoxy Resin Systems for Concrete Repair. This document describes epoxy repair materials for two types of application. They are: bonding hardened concrete to hardened concrete, and using as a binder in mortars and concrete. These types are further divided into classes based on working temperature. Thus, an appropriate material can be specified.

6.3 Recommendations by Substrate. Each different type of construction material may have a preferred surface preparation method. For substrates, grease and oil are usually removed by solvent or steam cleaning and mildew is killed and removed with a hypochlorite (bleach) solution, as described in par. 5.17.4.

6.3.1 Wood. Bare wood should not be exposed to direct sunlight for more than 2 weeks before priming. Sunlight causes photodegradation of surface wood-cell walls. This results in a cohesively weak layer on the wood surface which, when painted, may fail. If exposed, this layer should be removed prior to painting by sanding. Failure of paint caused by a degraded-wood surface is suspected when wood fibers are detected on the backside of peeling paint chips.

When the existing paint is intact, the surface should be cleaned with water, detergent, and bleach as needed to remove surface contaminants, such as soil, chalk, and mildew. When the existing paint is peeling and when leaded paint is not present, loose paint can be removed by hand scraping. Paint edges should be feathered by sanding. Power sanding may damage the wood if improperly done. Water and abrasive blasting are not recommended for wood, because these techniques can damage the wood. When leaded paint is present, special precautions, such as wet scraping, should be taken. Refer to Section 3.

Table 6
Commonly Used Methods of Surface Preparation for Coatings
(IMPORTANT NOTE: Methods may require modification or special control when leaded paint is present.)

Cleaning Method	Equipment	Comments
Organic solvent	Solvent such as mineral spirits, sprayers, rags, etc.	Removes oil and grease not readily removed by other methods; precautions must be taken to avoid fires and environmental contamination; local VOC regulations may restrict use.
Detergent/ power washing	Pumps, chemicals, sprayers, brushes	At pressures not exceeding 2000 psi, removes soil, chalk, mildew, grease, and oil, depending upon composition; good for smoke, stain, chalk and dirt removal.
Acid	Chemicals, sprayers, and brushes	Removes residual efflorescence and laitance from concrete after dry brushing. Thoroughly rinse afterwards.
Chemical paint strippers	Chemicals, sprayers, scrapers, washing equipment	Removes coatings from most substrates, but slow, messy, and expensive; may degrade surface of wood substrates.
Steam	Heating system pump, lines, and nozzles	Removes heavy oil, grease, and chalk; usually used prior to other methods.
Water blasting	High pressure water pumps, lines, and nozzles	At pressures of 2000 psi and above, removes loose paint from steel, concrete and wood; can damage wood or masonry unless care is taken; inhibitor generally added to water to prevent flash rusting of steel.
Hand tool	Wire brushes, chipping hammers, and scrapers	Removes only loosely adhering contaminants; used mostly for spot repair; slow and not thorough.
Power tool	Wire brushes, grinders, sanders, needle guns, rotary peelers, etc.	Faster and more thorough than hand tools because tightly adhering contaminants can be removed; some tools give a near-white condition on steel but not an angular profile; slower than abrasive blasting; some tools are fitted with vacuum collection devices.
Heat	Electric heat guns	Can be used to soften coatings on wood, masonry, or steel; softened coatings are scraped away, torches SHOULD NOT be used.
Abrasive blasting	Sand, metal shot, and metal or synthetic grit propelled onto metal by pressurized air, with or without water, or centrifugal force	Typically used on metal and, with care on masonry; can use recyclable abrasives; special precautions are needed when removing lead containing paint. Water may be added to control dust and its addition may require use of inhibitors. Vacuum blasting reduces dust but is slower than open. Centrifugal blasting is a closed cycle system in which abrasive is thrown by a spinning vaned wheel.

Paint should be removed from wood when failure is by cross-grain cracking (that is, cracking perpendicular to the wood grain). This failure occurs when the total paint thickness is too thick and/or the paint is too inflexible. Painting over this condition almost always results in early failure of the maintenance paint layer. Paint removal from wood is difficult and may not always be feasible. Chemical strippers can be used, but the alkaline types may damage (chemically degrade) the surface of the wood and cause a future peeling-paint failure. Failure caused by a stripper-degraded wood surface is more likely for exterior exposures than for interior exposures. This is because the greater expansion and contraction of wood in exterior exposures requires that the surface wood have a greater mechanical strength.

6.3.2 Concrete/Masonry. Bare concrete and masonry surfaces, as well as painted surfaces, are usually best cleaned with water and detergent. Use low-pressure washing (less than 2000 psi) or steam cleaning (ASTM D 4258) to remove loose surface contaminants from surfaces. Use high-pressure water blasting (greater than 2000 psi and usually about 5000 psi) (ASTM D 4259, Abrading Concrete) to remove loose old coatings or other more tightly held contaminants or chalk. If existing paints are leaded, special worker safety and environmental controls will be needed.

Abrasive blasting (ASTM D 4259 and D 4261, Surface Cleaning Concrete Unit Masonry for Coating) or acid etching of bare surfaces (ASTM D 4260, Acid Etching Concrete) may also be used to obtain a surface profile as well as clean surfaces for coating. Care must be taken to avoid damaging surfaces with high-pressure water or abrasives. Grease and oil must be removed with detergents or steam before abrasive blasting. Any efflorescence present should first be removed by dry wire brushing or acid washing. Special worker safety and environmental controls may be needed.

Concrete surfaces must be completely dry prior to paint application for all types of paints except waterborne. The plastic sheet method (ASTM D 4263, Indicating Moisture in Concrete by the Plastic Sheet Method) can be used to detect the presence of water (i.e., tape a piece of plastic sheet to the surface, wait 24 hours and look for condensed moisture under the sheet - the inside of the sheet should be dry).

6.3.3 Steel. The first step in preparing steel for coating is solvent cleaning as described in SSPC SP 1. Cleaning methods described in SSPC SP 1 include organic solvents, vapor degreasing, immersion in appropriate solvent, use of emulsion or alkaline cleaners, and steam cleaning with or without detergents.

SSPC SP 1 is specifically included as the first step in the SSPC surface preparation procedures.

For large areas of uncoated steel and coated steel with badly deteriorated coatings, the preferred method of removing mill scale, rust and coatings is abrasive blasting (SSPC SP 7, SSPC SP 6, SSPC SP 10, SSPC SP 5). These methods can both clean the surface and produce a surface profile. The specific abrasive method selected depends upon the conditions of the steel, the desired coating life, the environment and the coating to be applied. If leaded paint is present, special precautions must be taken to protect workers and the environment. Refer to Section 3. High-pressure water blasting, with or without injected abrasives, should be considered if dry abrasive blasting cannot be done because of environmental or worker safety restrictions.

For small localized areas, other cleaning methods such as hand tool cleaning (SSPC SP 2) or power tool cleaning (SSPC SP 3 or SSPC SP 11) may be more practical.

6.3.3.1 Specific Surface Preparation Requirements for Coatings for Steel. Different types of coatings may require different levels of cleaning. Commonly agreed upon minimum requirements are listed below. However, manufacturers of some specific coatings may require or recommend a cleaner surface. Conflicts between manufacturer's written instructions (tech data sheets) and contract specifications should be avoided.

<u>Coating</u>	<u>Minimum Surface Preparation</u>
Drying Oil	SSPC SP 2 or SSPC SP 3
Alkyd	SSPC SP 6 or SSPC-SP 11
	SSPC SP 3 for limited localized areas
Asphaltic	SSPC SP 6 or SSPC SP 11
Latex	SSPC SP 6 or SSPC SP 11
Vinyl Lacquer	SSPC SP 10
Chlorinated Rubber	SSPC SP 10
Epoxy	SSPC SP 6 or SSPC SP 10
Polyurethane	SSPC SP 10
Organic Zinc	SSPC SP 6 or SSPC SP 10
Inorganic Zinc	SSPC SP 10 or SSPC SP 5

For immersion or other severe environments, the higher level of the two options should be used. Higher levels may also be used to ensure the maximum lives from coating systems.

6.3.4 Galvanized and Inorganic-Zinc Primed Steel. The recommended method of cleaning uncoated galvanized steel varies with the condition of its surface. Simple solvent (organic or

detergent-based) cleaning (SSPC SP 1) is usually adequate for new galvanizing. This will remove oil applied to the galvanizing to protect it during exterior storage. If loose zinc corrosion products or coating are present on either galvanized or inorganic-zinc primed steel, they should be removed by bristle or wire brushing (SSPC SP 2 or SSPC SP 3) or water blasting. The method chosen must successfully remove the contaminants. Uniform corrosion of unpainted galvanizing may expose the brownish iron-zinc alloy. If this occurs, the surface should be painted as soon as possible. If rusting is present on older galvanized or on inorganic-zinc primed steel, remove the rust by sweep abrasive blasting (SSPC SP 7) or using power tools, such as wire brushing (SSPC SP 2, SSPC SP 3). Abrasive blasting is usually more appropriate when large areas are corroded, while the use of hand or power tools may be more appropriate when rusting is localized. For either method, the procedure should be done to minimize removal of intact galvanizing or of the inorganic zinc primer. Deteriorated coatings should also be removed using abrasive blasting or hand or power tools. When leaded-coatings are present, special worker safety and environmental precautions must be taken. Refer to Sections 3 and 13.

6.3.5 Aluminum and Other Soft Metals. New, clean aluminum and other soft metals may be adequately cleaned for coating by solvent cleaning (SSPC SP 1). The use of detergents may be required for removal of dirt or loose corrosion products. Abrasive blasting with plastic beads or other soft abrasives may be necessary to remove old coatings. Leaded coatings will require special worker safety and environmental precautions.

6.4 Standards for Condition of Substrates

6.4.1 Unpainted Steel. Verbal descriptions and photographic standards have been developed for stating the condition of existing steel substrates. SSPC VIS 1, Abrasive Blast Cleaned Steel (Standard Reference Photographs) illustrates and describes four conditions of uncoated structural steel. They are:

<u>Title</u>	<u>Grade</u>
Adherent mill scale	A
Rusting mill scale	B
Rusted	C
Pitted and rusted	D

Since the condition of the surface to be cleaned affects the appearance of steel after cleaning, these conditions are used in the SSPC VIS 1 cleanliness standards described below.

6.4.2 Nonferrous Unpainted Substrates. There are no standards describing the condition of other building material substrates.

6.5 Standards for Cleanliness of Substrates

6.5.1 Standards for Cleaned Steel Surfaces

6.5.1.1 SSPC and NACE Definitions and Standards. The SSPC and the NACE Standards are used most frequently for specifying degree of cleanliness of steel surfaces. SSPC has standard definitions and photographs for common methods of cleaning (SSPC VIS 1 and SSPC VIS 3, Power- and Hand-Tool Cleaned Steel). NACE TM0170, Surfaces of New Steel Air Blast Cleaned With Sand Abrasive; definitions and metal coupons) covers only abrasive blasting. Volume 2 of SSPC Steel Structures Painting Manual contains all the SSPC standards, as well as other useful information. For both types of standards, the definition, rather than the photograph or coupon, is legally binding. The SSPC and NACE surface preparation standards are summarized in Table 7.

To use the SSPC or NACE standards, first determine the condition of steel that is to be blasted (e.g., Grade A, B, C, or D), since different grades of steel blasted to the same level do not look the same. After determining the condition of steel, compare the cleaned steel with the pictorial standards for that condition. The appearance of blasted steel may also depend upon the type of abrasive that is used. NACE metal coupons represent four degrees of cleanliness obtained using one of three types of abrasives - grit, sand, or shot.

6.5.1.2 Job-Prepared Standard. A job-specific standard can be prepared by blasting or otherwise cleaning a portion of the structure to a level acceptable to both contractor and contracting officer, and covering it with a clear lacquer material to protect it for the duration of the blasting. A 12-inch steel test plate can also be cleaned to an acceptable level and sealed in a water- and grease-proof bag or wrapper conforming to MIL-B-131, Barrier Materials, Water Vaporproof, Greaseproof, Flexible, Heat-Sealable.

6.5.1.3 Pictorial Standards for Previously Painted Steel. Photographic standards for painted steel are available in the Society for Naval Architects and Engineers Abrasive Blasting Guide for Aged or Coated Steel Surfaces. Pictures representing paint in an original condition and after each degree of blasting are included.

Table 7
SSPC and NACE Standards for Cleaned Steel Surfaces

Method	SSPC No.	NACE No.	Intended Use
Solvent Cleaning	SSPC SP 1		Removal of oil and grease prior to further cleaning by another method
Hand Tool	SSPC SP 2		Removal of loose mill scale, rust, and paint
Power Tool	SSPC SP 3		Faster removal of loose mill scale, rust, and coatings than hand tool cleaning
White Metal Blast	SSPC SP 5	NACE 1	Removal of visible contaminants on steel surfaces; highest level of cleaning for steel
Commercial Blast	SSPC SP 6	NACE 3	Removal of all visible contaminants except that one third of a steel surface may have shadows, streaks, or stains
Brush-Off Blast	SSPC SP 7	NACE 4	Removal of loose mill scale, rust, and paint (loose paint can be removed with dull putty knife)
Pickling	SSPC SP 8		Removal of mill scale and rust from steel
Near-White Blast	SSPC SP 10	NACE 2	Removal of visible contaminants except that 5 percent of steel surfaces may have shadows, streaks, or stains
Power Tool Cleaning	SSPC SP 11		Removal of visible contaminants (surface is comparable to SSPC SP 6, also provides profile)

6.5.2 Standards for Cleaned Nonferrous Metals. No industry standards describe the degree of cleaning of nonferrous metals, and previously painted non-steel substrates.

6.5.3 Previously Coated Surfaces. When the surface to be painted is an old weathered coating film (that is, surface preparation will not include removal of the old coating), ASTM visual standards should be used for chalk, mildew, and dirt removal. In general, a minimum chalk rating (ASTM D 4214, Evaluating Degree of Chalking of Exterior Paint Films) of 8 should be required for chalk removal, a minimum mildew removal rating (ASTM D 3274, Evaluating Degree of Surface Disfigurement of Paint) of 8 (preferably 10) should be required for mildew removal, and an ASTM D 3274 rating of 10 should be required for dirt removal. Consideration should be given to requiring preparation of a job-specific standard (as described in par. 6.5.1.2) when large jobs are contracted. This standard should cover removal of loose material, chalk, and mildew, as well as feathering of edges, and other requirements of the contract specification.

6.6 Recommendations for Paint Removal. It is often necessary to remove old coatings that are peeling, checking, cracking, or the like. General recommendations for removal of paint from a variety of substrates are made in Table 8. More specific information is provided in par. 6.7.

Table 8
 Procedures for Coating Removal
 (IMPORTANT NOTE - Presence of Leaded Paint Will Require
 Environmental and Worker Safety Controls)

Substrate	Methods
Wood	Chemical removers; heat guns or hot plates along with scraping; power sanding (must be done with caution to avoid damaging wood).
Masonry	Careful water blasting to avoid substrate damage; brush-off blasting and power tools, used with caution.
Steel	Abrasive blasting; water blasting.
Miscellaneous metals	Chemicals; brush-off blast; water blast

6.7 Methods of Surface Preparation. Information on surface preparation methods and procedures are presented to help select appropriate general procedures and to inspect surface preparation jobs. It is not intended to be a complete source of information for those doing the work.

6.7.1 Abrasive Blasting. Abrasive blast cleaning is most often associated with cleaning painted and unpainted steel. It may also be used with care to prepare concrete and masonry surfaces and to clean and roughen existing coatings for painting. Abrasive blasting is an impact cleaning method. High-velocity abrasive particles driven by air, water, or centrifugal force impact the surface to remove rust, mill scale, and old paint from the surfaces. Abrasive cleaning does not remove oil or grease. If the surface to be abrasive blasted is painted with leaded paint, additional controls must be employed to minimize hazards to workers and the surrounding environment. Leaded paint issues are discussed in more detail in Section 3.

There are four degrees of cleanliness of blast cleaning designated by the SSPC and the NACE for steel substrates. These designations are white metal, near-white metal, commercial, and brush-off. They are described in detail in par. 6.5.1.1. The

degree of cleanliness obtained in abrasive blasting depends on the type of abrasive, the force with which the abrasive particles hits the surface, and the dwell time.

6.7.1.1 Types of Abrasive Blasting

a) Air (Conventional). In conventional abrasive blasting (Figure 1), dry abrasive is propelled against the surface to be cleaned so that rust, contaminants, and old paint are removed by the impact of the abrasive particles. The surface must be cleaned of blasting residue before painting. This is usually done by blowing clean air across the surfaces. Special care must be taken to ensure that horizontal or other obstructed areas are thoroughly cleaned. Uncontrolled abrasive blasting is restricted in most locations because of environmental regulations. Consult the local industrial hygiene or environmental office for regulations governing local actions. Procedures for containment of blasting debris are being used for paint removal from industrial and other structures. The SSPC has developed a guide (SSPC Guide 6I) for selecting containment procedures depending upon the degree of containment desired. The amount of debris generated can be reduced by recycling the abrasive. Recycling systems separate the paint waste from the abrasive.

b) Wet. Wet-abrasive blasting is used to control the amount of airborne dust. There are two general types of wet abrasive blasting. In one, water is injected near the nozzle exit into the stream of abrasive (Figure 2). In the other, water is added to the abrasive at the control unit upstream of the nozzle and the mixture of air, water, and sand is propelled through the hose to the nozzle. For both types of wet-blasting, the water may contain a corrosion inhibitor. Inhibitors are generally sodium, potassium, or ammonium nitrites, phosphates or dichromates. Inhibitors must be chosen to be compatible with the primer that will be used. After wet blasting, the surface must be rinsed free of spent abrasive. (The rinse water should also contain a rust inhibitor when the blasting water does.) Rinsing can be a problem if the structure contains a large number of ledges formed by upturned angles or horizontal girders since water, abrasives, and debris tend to collect in these areas. The surface must be completely dry before coating. When leaded paint is present, the water and other debris must be contained and disposed of properly. This waste may be classified as a hazardous waste under Federal and local regulations, and must be handled properly.

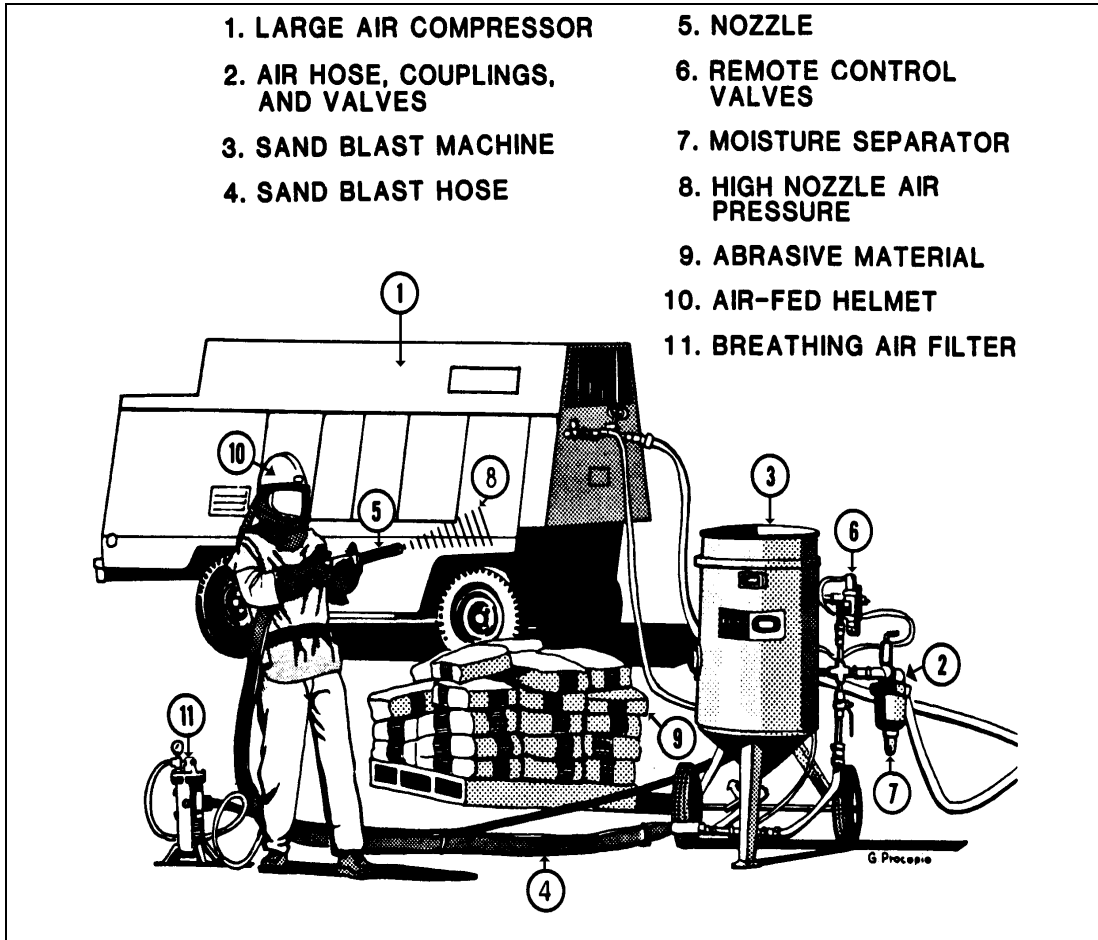

Figure 1
Schematic Drawing Illustrating Components of Conventional
Abrasive Blasting Equipment

c) Vacuum. Vacuum blasting systems collect the spent abrasives and removed material, immediately adjacent to the point of impact by means of a vacuum line and shroud surrounding the blasting nozzle. Abrasives are usually recycled. Production is slower than open blasting and may be difficult on irregularly shaped surfaces, although shrouds are available for non-flat surfaces. The amount of debris entering the air and the amount of cleanup is kept to a minimum if the work is done properly (e.g., the shroud is kept against the surface). This procedure is often used in areas where debris from open air blasting or wet blasting cannot be tolerated.

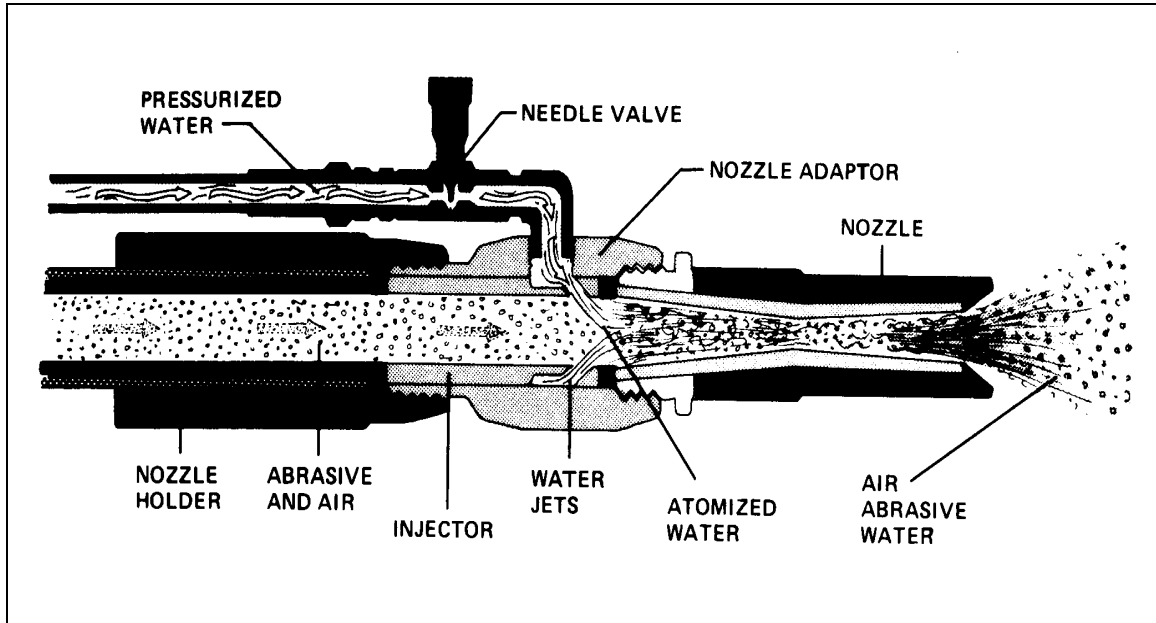

Figure 2
Schematic Drawing of Cross Section of Typical Water-Injected
Wet Abrasive Blasting Nozzle

d) Centrifugal. Cleaning by centrifugal blasting is achieved by using machines with motor-driven bladed wheels to hurl abrasives at a high speed against the surface to be cleaned. Advantages over conventional blasting include savings in time, labor, energy, and abrasive; achieving a cleaner, more uniform surface; and better environmental control. Disadvantages of centrifugal blasting include the difficulty of using it in the field, especially over uneven surfaces, although portable systems have been developed for cleaning structures such as ship hulls and storage tanks. Robots may be used to guide the equipment. In many cases, the abrasive used is reclaimed and used again.

6.7.1.2 Conventional Abrasive Blasting Equipment. Components of dry abrasive blasting equipment are air supply, air hose and couplings, abrasive blast machines, abrasive blast hose and couplings, nozzles, operator equipment, and oil and moisture separators. A brief description of each component follows:

a) Air Supply. The continuous and constant supply of an airstream of high pressure and volume is one of the most critical parts of efficient blasting operations. Thus, the air supply (compressor) must be of sufficient capacity. Insufficient air supply results in excessive abrasive use and slower cleaning

rates. The compressor works by taking in, filtering, and compressing a large volume of air by rotary or piston action and then releasing it via the air hose into the blasting machine. The capacity of a compressor is expressed in volume of air moved per unit time (e.g., cubic feet per minute (cfm)) and is directly related to its horsepower. The capacity required depends upon the size of the nozzle orifice and the air pressure at the nozzle. For example, a flow of 170 to 250 cfm at a nozzle pressure of 90 to 100 psi is necessary when using a nozzle with a 3/8 to 7/16 inch orifice. This typically can be achieved with a 45 to 60 horsepower engine.

b) Air-Supply Hose. The air-supply hose delivers air from the compressor to the blasting machine. Usually the internal diameter should be three to four times the size of the nozzle orifice. The length of the hose should be as short as practical because airflow through a hose creates friction and causes a pressure drop. For this reason, lines over 100 feet long generally have internal diameters four times that of the nozzle orifice.

c) Blasting Machine. Blasting machines or "sand pots" are the containers which hold the abrasives. The capacity of blasting machines varies from 50 pounds to several tons of abrasive material. The blasting machine should be sized to maintain an adequate volume of abrasive for the nozzles.

d) Abrasive Blasting Hose. The abrasive blasting hose carries the air and abrasive from the pot to the nozzle. It must be sturdy, flexible, and constructed or treated to prevent electrical shock. It should also be three to four times the size of the nozzle orifice, except near the nozzle end where a smaller diameter hose is attached.

e) Nozzles. Nozzles are available in a great variety of shapes, sizes, and designs. The choice is made on the basis of the surface to be cleaned and the size of the compressor. The Venturi design (that is, large throat converging to the orifice and then diverging to the outlet, Figure 3) provides increased speed of abrasive particles through the nozzle as compared with a straight bore nozzle. Thus, the rate of cleaning is also increased. Nozzles are available with a variety of lengths, orifice sizes, and lining materials. The life of a nozzle depends on factors such as the lining material and the abrasives and varies from 2 to 1500 hours. Nozzles should be inspected regularly for orifice size and wear. Worn nozzles result in poor cleaning patterns and efficiency.

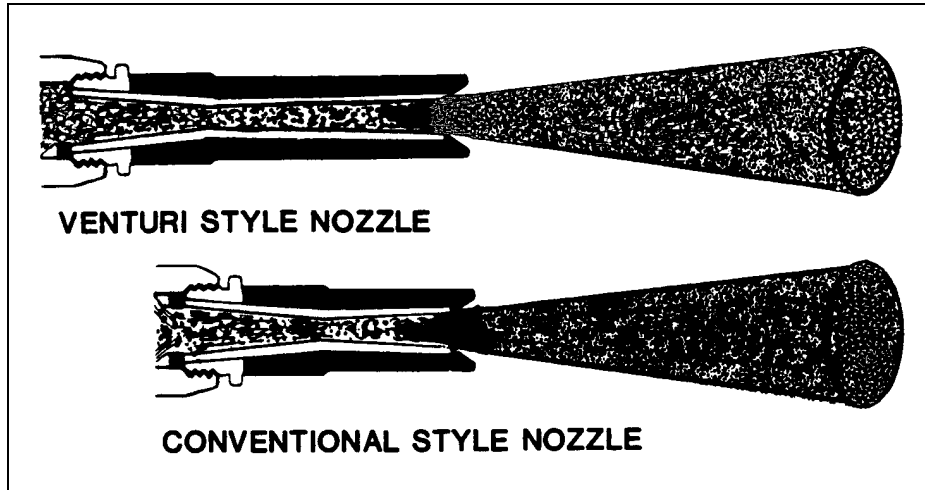

Figure 3
Cross-Sectional Drawing of Nozzles

f) Oil/Moisture Separators. Oils used in the compressor could contaminate the air supply to the nozzles. To combat this, oil/moisture separators are installed at the blast machine. The separators require periodic draining and routine replacement of filters. Contamination of the air supply can be detected by a simple blotter test. In this test, a plain, white blotter is held 24 inches in front of the nozzle with only the air flowing (i.e., the abrasive flow is turned off) for 1 to 2 minutes. If stains appear on the blotter, the air supply is contaminated and corrective action is required. ASTM D 4285, Indicating Oil or Water in Compressed Air describes the testing procedure in more detail.

g) Operators Equipment. The operators equipment includes a protective helmet and suit. The helmet must be air-fed when blasting is done in confined or congested areas. To be effective it must furnish respirable air to the operator at a low noise level, protect the operator from rebounding abrasive particles, provide clear vision to the operator, and be comfortable and not restrictive. Air-fed helmets must have National Institute of Safety and Hygiene (NIOSH) approval. Refer to Section 13 for additional information.

h) Wet Blasting. In addition to equipment needed for dry abrasive blasting, metering, delivery, and monitoring devices for water are needed.

i) Vacuum Blasting. Although there are many designs for vacuum blasting equipment, all systems have a head containing a blast nozzle, surrounded by a shroud connected to a vacuum system, and a collection chamber for debris.

j) Centrifugal Blasting. In centrifugal blasting, abrasive is hurled by wheels instead of being air-driven. This type of blasting is often used in shop work. Portable devices have been developed for use on flat surfaces. Abrasive is contained and usually recycled.

6.7.1.3 Abrasive Properties. The SSPC has a specification for mineral and slag abrasive, SSPC AB 1, Mineral and Slag Abrasives. Abrasives covered by the specification are intended primarily for one-time use without recycling. The specification has requirements for specific gravity, hardness, weight change on ignition, water soluble contaminant, moisture content and oil content. MIL-A-22262, Abrasive Blasting Media, Ship Hull Blast Cleaning, a Navy Sea Systems specification for abrasives, also limits the heavy metal content of abrasives. These and other properties of abrasives are discussed below:

a) Size. Abrasive size is a dominant factor in determining the rate of cleaning and the profile obtained. A large abrasive particle will cut deeper than a small one of the same shape and composition, however, a greater cleaning rate is generally achieved with smaller-sized particles. Thus, a mix is generally used.

b) Shape. The shape and size of abrasive particles determine the surface profile obtained from blasting (Figure 4). Round particles, such as shot, produce a shallow, wavy profile. Grit, which is angular, produces a jagged finish. Usually a jagged finish is preferred for coating adhesion. Round particles are well suited for removal of brittle contaminants like mill scale and are also used when little or no change in surface configuration is permitted. Sand and slag, which are semi-angular, produce a profile that is somewhere between that of shot and grit. Currently, sand is used much less than other abrasives because of health and breakdown factors.

c) Hardness. Hard abrasives usually cut deeper and faster than soft abrasives. Hence, hard abrasives are best suited for blast cleaning jobs where the objective is to remove surface coatings. Soft abrasives, such as walnut hulls, can remove light contaminants without disturbing a metal substrate or, in some cases, the existing coating system.

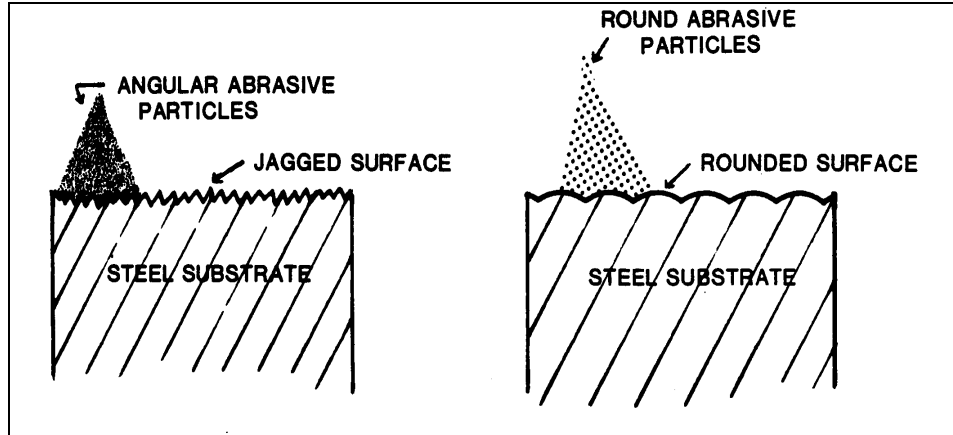

Figure 4

Drawing Illustrating Effect of Shape of Abrasive Particle on Contour of Blast-Cleaned Metallic Substrate

d) Specific Gravity. Generally the more dense a particle, the more effective it is as an abrasive. This is because it takes a certain amount of kinetic energy to remove contaminants from the surface and the kinetic energy of an abrasive particle is directly related to its density (specific gravity).

e) Breakdown Characteristics. Abrasive particles striking the surface at high speeds are themselves damaged. The way in which they fracture (breakdown) and/or in which they change their shape and size is called their breakdown characteristic. An excessive breakdown rate results in a significant increase in dusting, requires extra surface cleaning for removal of breakdown deposits, and limits the number of times the abrasive can be reused.

f) Water-Soluble Contaminants. ASTM D 4940, Conductimetric Analysis of Water Soluble Ionic Contamination of Blasting Abrasives describes a conductivity test for determining the level of contamination of metallic, oxide, slags, and synthetic abrasives by water-soluble salts. SSPC AB 1 requires that the conductivity of the test solution be below 100 microsiemens.

6.7.1.4 Abrasive Types. Abrasives fall into seven general categories: metallic, natural oxides, synthetic, slags, cellulose (such as walnut hulls), dry ice pellets (carbon dioxide), sodium bicarbonate, and sponge. A summary of typical properties of some of these abrasives is found in Table 9.

Table 9
Typical Physical Characteristics of Abrasives (1)

	Hardness	Shape	Specific Gravity	Bulk Density (pounds per cubic foot)	Color	Free Silica Wt Percent	Degree of Dusting
Naturally Occurring Abrasives							
	(Mohs Scale)						
Sands:							
Silica	5	Rounded	2 to 3	100	White	90 +	High
Mineral	5 to 7	Rounded	3 to 4	123	Variable	< 5	Medium
Flint	6.7 to 7	Angular	2 to 3	80	Lt. Grey	90 +	Medium
Garnet	7 to 8	Angular	4	145	Pink	Nil	Medium
Zircon	7.5	Cubic	4.5	185	White	Nil	Low
Novaculite	4	Angular	2.5	100	White	90 +	Low
By-Product Abrasives							
	(Mohs Scale)						
Slags:							
Boiler	7	Angular	2.8	85	Black	Nil	High
Copper	8	Angular	3.3	110	Black	Nil	Low
Nickel	8	Angular	2.7	85	Green	Nil	High
Walnut Shells	3	Cubic	1.3	45	Brown	Nil	Low
Corn Cobs	4.5	Angular	1.3	30	Tan	Nil	Low
Manufactured Abrasives							
	(Mohs Scale)						
Silicon Carbide	9	Angular	3.2	105	Black	Nil	Low
Aluminum Oxide	8	Blocky	4.0	120	Brown	Nil	Low
Glass Beads	5.5	Spherical	2.5	100	Clear	67	Low
Metallic Abrasives							
	(Rockwell C)						
Cast Steel (2) Shot & Grit	as spec. or range 35-65 RC	Spherical or Angular	3 to 10		Grey	Nil	
Malleable Iron Shot or Grit	range: 28-40 RC	Spherical or Angular	3 to 10		Grey	Nil	
Chilled Cast Iron Shot or Grit	range: 57-65 RC	Spherical or Angular	3 to 10		Grey	Nil	

- NOTES: (1) Taken from SSPC SP COM, Steel Structures Painting Manual, Systems and Specifications, Vol. 2, p. 17, and Vol. 1 of Good Painting Practice, p. 34.
- (2) Represents 85 percent of the metallic abrasives used.

a) Metallic. Steel shot and grit are the most commonly used metallic abrasives. Metallic abrasives are used to remove mill scale, rust, and old paint and provide a suitable anchor pattern. The advantages of metallic abrasives include longer useful life (can be recycled many times), greater impact energy for given particle size, reduced dust formation during blasting, and minimal embedment of abrasive particles. The disadvantages include blast cleaning equipment must be capable of recycling, abrasives must be kept dry to prevent corrosion, and the impact of steel shot on metal surfaces may cause formation of hackles on the surface. These hackles are relatively long slivers of metal and must be removed mechanically by sanding or grinding before coating to prevent pinpoint corrosion through the paint film.

b) Natural Oxides. Silica is the most widely used natural oxide because it is readily available, low in cost, and effective. Sand particles range from sharply angular to almost spherical, depending on the source. OSHA and EPA regulations have restricted the use of sand in many areas. Nonsilica sands (generally termed "heavy mineral" sands) are also being used for blast cleaning. However, they are generally of finer particle size than silica sand and are usually more effectively used for cleaning new steel than for maintenance applications.

c) Synthetics. Aluminum oxide and silicon carbide are nonmetallic abrasives with cleaning properties similar to the metallics and without the problem of rusting. They are very hard, fast-cutting and low-dusting, but they are costly and must be recycled for economical use. They are often used to clean hard, high tensile strength metals.

d) Slags. The most commonly used slags for abrasives are by-products from metal smelting (metal slags) and electric power generation (boiler slags). Slags are generally hard, glassy, homogeneous mixtures of various oxides. They usually have an angular shape, a high breakdown rate, and are not suitable for recycling.

e) Cellulose Type. Cellulose type abrasives, such as walnut shells and corncobs, are soft, low density materials used for cleaning of complex shaped parts and removing dirt, loose paint, or other deposits on paint films. Cellulose type abrasives will not produce a profile on a metal surface.

f) Dry Ice. Special equipment is used to convert liquid carbon dioxide into small pellets which are propelled against the surface. Since the dry ice sublimates, the abrasive leaves no residue. The method can be used to remove paint from

some substrates, but not mill scale and will not produce a profile. Paint removal is slow (and very difficult from wood) and the equipment needed to carry out the blasting is expensive.

g) Sponge. Specially manufactured sponge particles, with or without impregnated hard abrasive, are propelled against the surface. Less dust is created when sponge abrasive is used as compared to expendable or recyclable abrasives. The sponge is typically recycled several times. If sponge particles with impregnated hard abrasive are used, a profile on a metal can be produced. Sponge blasting is typically slower than with conventional mineral or steel abrasives.

h) Sodium Bicarbonate. Sodium bicarbonate particles are propelled against the surface, often in conjunction with high-pressure water. This method provides a way to reduce waste if the paint chips can be separated from the water after cleaning since sodium bicarbonate is soluble in water. These particles can be used to remove paint, but not mill scale or heavy corrosion.

6.7.1.5 Selection. Selection of the proper abrasive is a critical part of achieving the desired surface preparation. Factors that influence the selection include: desired degree of cleanliness; desired profile; degree of rusting; deep pits; and kind and amount of coating present. Since obtaining the desired degree of cleanliness and profile are the main reasons for impact cleaning, they must be given priority over all other factors except environmental ones in abrasive selection.

6.7.1.6 Inspection. Abrasives must be dry and clean. It is most important that they are free of inorganic salts, oils, and other contaminants. There are only limited standard procedures for inspecting abrasives. The following general procedure is suggested:

a) Visually inspect the abrasive to ensure that it is dry,

b) Test for presence of water soluble salts by following ASTM D 4940 in which equal volumes of water and abrasive are mixed and allowed to stand for several minutes and the conductivity of the supernatant is measured using a conductivity cell and bridge,

c) Examine the supernatant of the ASTM D 4940 test for presence of an oil film.

6.7.1.7 Procedures/General Information. Good blasting procedures result in efficient and proper surface preparation. Adequate pressure at the nozzle is required for effective blasting. Other factors, such as flow of abrasive, nozzle wear, position of the nozzle with respect to the surface, and comfort of operator are also important. A well trained operator is essential to obtaining an acceptable job.

a) Handling the Nozzle. The angle between the nozzle and the surface and the distance between the nozzle and surface are important factors in determining the degree and rate of cleaning (Figure 5). The working angle will vary from 45 to 90 degrees depending upon the job. To remove rust and mill scale, the nozzle is usually held at an angle of between 80 and 90 degrees to the surface. This is also the preferred configuration for cleaning pitted surfaces. A slight downward angle will direct the dust away from the operator and ensure better visibility. A larger angle between nozzle and surface allows the operator to peel away heavy coats of old paint and layers of rust by forcing the blast under them. Other surface contaminants may be better removed with a cleaning angle of from 60 to 70 degrees. By varying the distance between the nozzle and the surface, the type and rate of cleaning can also be varied. The closer the nozzle is to the surface, the smaller the blast pattern and the more abrasive strikes it. Thus, a greater amount of energy impacts the surface per unit area than if the nozzle were held further away. A close distance may be required when removing tight scale, for example. However, a greater distance may more effectively remove old paint. Once an effective angle and distance have been determined, each pass of the nozzle should occur in a straight line to keep the angle and distance between the nozzle and the surface the same (Figure 6). Arcing or varying the distance from the surface will result in a nonuniform surface.

b) Rates. The rate of cleaning depends on all of the factors discussed above. Abrasive blasting of steel to a commercial degree of cleanliness (SSPC SP 6 or better) is much slower than painting. No more steel surface area should be blast cleaned at one time than can be primed the same day, since significant rusting can occur overnight. If rusting does occur, the surface must be reblasted before painting.

6.7.2 Acid Cleaning. Acid cleaning is used for cleaning efflorescence and laitance from concrete.

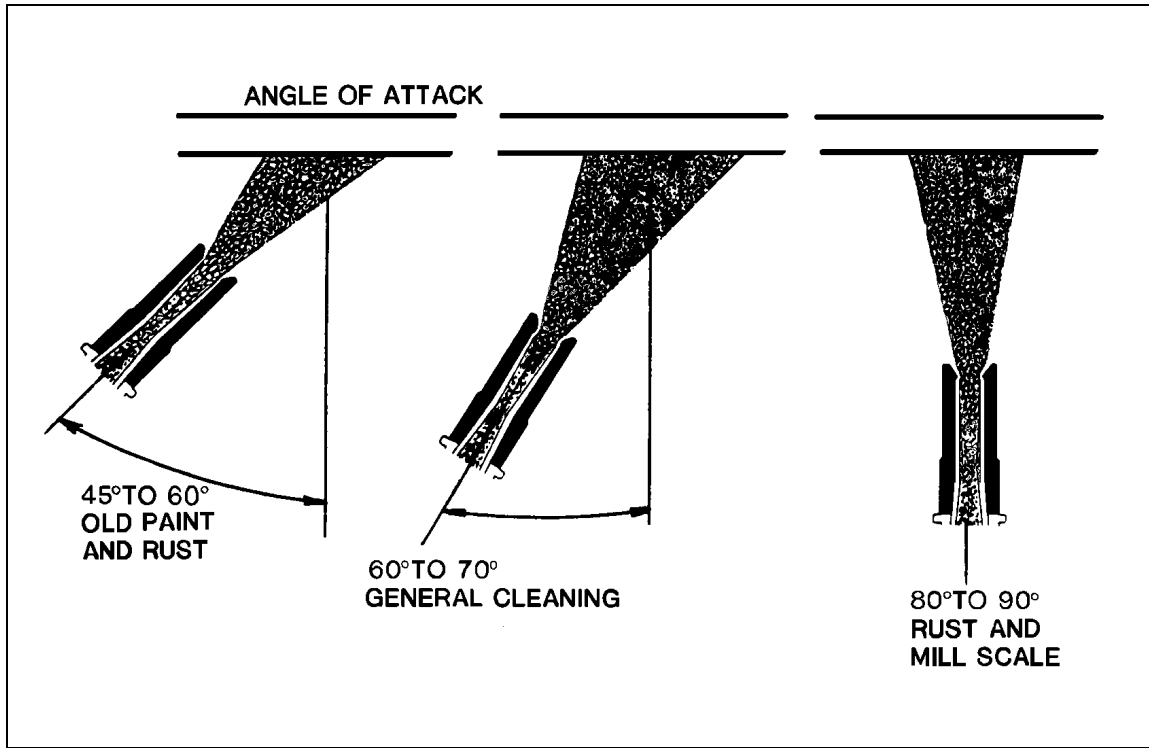

Figure 5
Schematic Illustrating Typical Cleaning Angles
for Various Surface Conditions

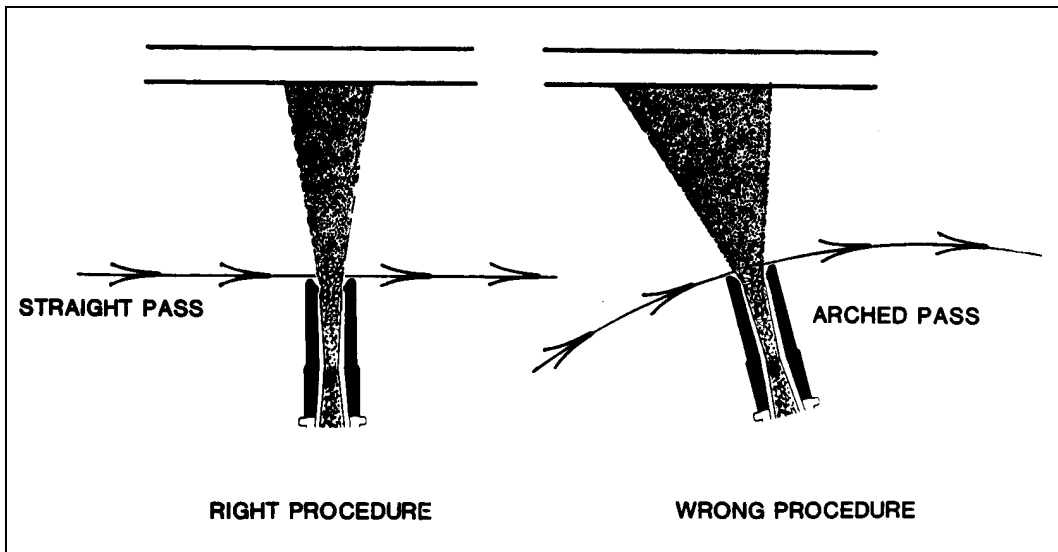

Figure 6
Illustration of Proper Stroke Pattern for Blast Cleaning

6.7.2.1 Concrete. Heavy efflorescence and laitance should be removed from concrete surfaces by dry brushing or cleaning prior to acid cleaning. This is to prevent dissolution of the efflorescence and subsequent movement of the salts into the concrete. Prior to application of an acid solution, heavy oil, grease, and soil deposits must also be removed. Oily dirty deposits can be removed by solvent or detergent washing. The commonly used procedure to acid clean these surfaces is to thoroughly wet the surface with clean water; uniformly apply acid solution (often a 5 to 10 percent solution of hydrochloric (muriatic) acid solution or a solution of phosphoric acid); scrub the surface with a stiff bristle brush; and immediately rinse the surface thoroughly with clean water. Measure the pH of the surface and rinse water using pH paper (ASTM D 4262, pH of Chemically Cleaned or Etched Concrete Surfaces). In general, the pH should be within one pH unit of fresh rinse water. It is essential for good paint performance that the acid be neutralized before painting. Work should be done on small areas, not greater than 4 square feet in size. This procedure or light abrasive blasting can also be used to etch the surface of very smooth concrete prior to coating. Coating adhesion on slightly rough concrete surfaces is usually much better than on smooth and (e.g., troweled) surfaces. An acid etched surface is usually roughened to a degree similar in appearance to a medium grade sandpaper. This cleaning method is described in detail in ASTM D 4260.

6.7.3 Chemical Removal of Paint. Paint strippers can be used when complete paint removal is necessary and other methods, such as abrasive blasting, cannot be used due to environmental restraints or potential damage to the substrate. Removers are selected according to the type and condition of the old coating as well as the nature of the substrate. They are available as flammable or nonflammable types and in liquid or semi-paste types. While most paint removers require scraping or other mechanical means to physically remove the softened paint, types are available that allow the loosened coating to be flushed away with steam or hot water. If paint being removed contains lead, additional environmental and worker safety precautions will be needed. Many removers contain paraffin wax to retard evaporation and this residue must be removed prior to recoating. Always follow manufacturer's recommendations. In addition, surrounding areas (including shrubs, grass, etc.) should be protected from exposure to the remover, collection of the residue will probably be required by environmental regulations. Removers are usually toxic and may cause fire hazards. Management of the waste associated with the procedure will also be necessary. Consult the local environmental and safety offices for further information.

6.7.4 Detergent Washing. Detergent washing or scrubbing is an effective way to remove soil, chalk and mildew. Detergent cleaning solutions may be applied by brush, rags, or spray. An effective solution for removal of soil and chalk is 4 ounces of trisodium phosphate, 1 ounce household detergent, and 4 quarts of water. For mildew removal, 1 part of 5 percent sodium hypochlorite solution (household bleach) is added to 3 parts of the cleaning solution used for chalk and soil removal. Of course, if there is little or no existing chalk on the surface, the cleaning solution should not contain the trisodium phosphate. Note, that sodium hypochlorite solution (household bleach) must not be added to cleaning solutions containing ammonia or other similar chemicals. Toxic fumes will be produced. Thorough rinsing with water is absolutely necessary to remove the soapy alkaline residues before recoating. To test the effectiveness of the rinse, place pH paper against the wet substrate and in the rinse water and compare the pH of the two. (Refer to ASTM D 4262 for complete description of the procedure.) The pH of the substrate should be no more than one pH unit greater than that of the rinse water.

6.7.5 Hand Tool Cleaning. Hand cleaning is usually used only for removing loosely adhering paint or rust. Any grease or oil must be removed prior to hand cleaning by solvent washing. Hand cleaning is not considered an appropriate procedure for removing tight mill scale or all traces of rust and paint. It is slow and, as such, is primarily recommended for spot cleaning in areas where deterioration is not a serious factor or in areas inaccessible to power tools. Hand tools include wire brushes, scrapers, abrasive pads, chisels, knives, and chipping hammers. SSPC SP 2 describes standard industrial hand-tool cleaning practices for steel. Since hand cleaning removes only the loosest contaminants, primers applied over hand-tool cleaned surfaces must be chosen that are capable of thoroughly wetting the surface. Paint performance applied to hand-cleaned steel surfaces is not as good as that applied over blast cleaned surfaces.

6.7.6 Heat. Electric heat guns and heat plates are used to remove heavy deposits of coatings on wood and other substrates. The gun or plate is positioned so that the coating is softened and can be removed by scraping. Production rates depend upon the thickness of the old coating and the smoothness of the substrate. There is a possibility of creating toxic fumes, or conditions in which burns are possible. The use of torches is not recommended, although they have been used to remove greasy contaminants and paints from surfaces prior to painting. This is an extremely dangerous procedure. The SSPC no longer has a surface preparation standard for flame cleaning because of the danger involved.

6.7.7 Organic Solvent Washing. Solvent cleaning is used for removing oil, grease, waxes, and other solvent-soluble matter from surfaces. VOC rules may prohibit or limit the use of solvent cleaning. The local environmental and safety office should be consulted before using or specifying solvent cleaning. Inorganic compounds, such as chlorides, sulfates, rust, and mill scale are not removed by solvent cleaning. Solvent cleaning or detergent or steam washing must precede mechanical cleaning when oil and grease are present on the surface because mechanical and blast cleaning methods do not adequately remove organic contaminants and may spread them over the surface. Before solvent washing, any soil, cement splatter, or other dry contaminants must first be removed. The procedure for solvent washing is to: wet the surface with solvent by spraying or wiping with rags wet with solvent; wipe the surface with rags; and make a final rinse with fresh solvent. Fresh solvent must be used continuously and the rags must be turned and replaced continuously. Solvents rapidly become contaminated with oils and grease since they clean by dissolving and diluting contaminants. Mineral spirits is effective in most solvent cleaning operations. SSPC SP 1 describes recommended industry practices for cleaning steel using solvents.

Organic solvents pose health and safety threats and should not come into contact with the eyes or skin or be used near sparks or open flames. Table 3-5 lists the flash points (the lowest temperature at which an ignitable mixture of vapor and air can form near the surface of the solvent) and relative toxicity of common solvents. Disposal of solvent must be done in accordance with governing regulations. Rags must be placed in fireproof containers after use. Additional safety information is contained in Section 13.

6.7.8 Power Tool Cleaning. Power tool cleaning can be used to remove more tightly adhering contaminants and existing paint than hand tool cleaning. Either electrical or pneumatic power is used as the energy source. Power tool cleaning is recommended when deterioration is localized, deterioration is not a serious problem, or when abrasive blasting is not possible. SSPC SP 3 and SSPC SP 11 describe the use of some of these tools for steel. In general, power tool cleaning is less economical and more time consuming than blasting for cleaning large areas. However, power tools do not leave as much residue or produce as much dust as abrasive blasting. Also, some power tools are equipped with vacuum collection devices. Power tools include sanders, grinders, wire brushes, chipping hammers, scalers, needle guns, and rotary peelers. Power tools clean by impact or abrasion or both. Near-white (i.e., rust and paint removed) steel surfaces with anchor patterns (although different than those achieved in blast cleaning) can be obtained with some power tools, as

described in SSPC SP 11. Care must be taken when using wire brushes to avoid burnishing the surface and thus causing a reduced adhesion level of the primer coating. Grease and oil must be removed prior to power tool cleaning. Danger from sparks and flying particles must always be anticipated. The operator and adjacent workers must wear goggles or helmets and wear protective clothing. No flammable solvents should be used or stored in the area. Refer to Section 13 for further safety details.

6.7.9 Steam Cleaning. A high-pressure jet of steam (about 300 degrees F, 150 psi), usually with an added alkaline cleaning compound, will remove grease, oil, and heavy dirt from surfaces by a combination of detergent action, water, heat and impact (refer to SSPC SP 1). The steam is directed through a cleaning gun against the surface to be cleaned. The pressure is adjusted to minimize spraying time. Any alkaline residue remaining on the surface after the cleaning operation must be removed by thorough rinsing with fresh water. Alkali cleaners used in steam cleaning may attack aluminum and zinc alloys and should not be used on these substrates. Steam cleaning may cause old paints to swell and blister. Thus, when steam cleaning previously painted surfaces, the cleaning procedure should first be tested in a small area to assess the effect on the old paint.

Steam cleaning equipment is usually portable and is one of two designs. With one type of equipment, concentrated cleaning solution is mixed with water, fed through a heating unit so that it is partially vaporized, pressurized, and forced through a nozzle. With another type of equipment, sometimes called a hydro-steam unit, steam from an external source is mixed with the cleaning solution in the equipment or in the nozzle of the cleaning gun. The shape of the nozzle is chosen according to the contour of the surface being cleaned. Steam cleaning is dangerous and extreme caution should be exercised with the equipment. A dead man valve must be included in the equipment and the operator must have sound, safe footing. Workers engaged in steam cleaning operations must be protected from possible burns and chemical injury to the eyes and skin by protective clothing, face shields, and the like. Refer to Section 13 for safety details.

6.7.10 Water Blast Cleaning. Water blast cleaning uses a high-pressure water stream to remove lightly adhering surface contaminants. Selection of water pressure and temperature and addition of a detergent depend on the type of cleaning desired. Low pressure - up to 2000 psi - (sometimes called "power washing") is effective in removing dirt, mildew, loose paint, and chalk from surfaces. It is commonly used on metal substrates and generally does little or no damage to wood, masonry, or concrete

substrates. For removing loose flaky rust and mill scale from steel, water pressures as high as 10,000 psi or more and volumes of water to 10 gallons per minute are used. However, water blasting without an added abrasive does not provide a profile. By introducing abrasives into the water stream, the cleaning process becomes faster and an anchor pattern is produced. Hydroblasting at high pressures can be dangerous and extreme caution should be exercised with the equipment. A dead man valve must be included in the equipment and the operator must have sound, safe footing. He should wear a rain suit, face shield, hearing protection, and gloves. Additional safety equipment may be needed. Further safety procedures are described in Section 13.

6.7.10.1 Equipment. The basic water blasting unit (without injection of an abrasive) consists of an engine-driven pump, inlet water filter, pressure gauge, hydraulic hose, gun, and nozzle combination. As with the equipment for abrasive blasting, the gun must be equipped with a "fail-safe" valve so that the pressure is relieved when the operator releases the trigger. Nozzle orifices are either round or flat. The selection depends on the shape of the surface to be cleaned. Flat orifices are usually used on large flat surfaces. Nozzles should be held about 3 inches from the surface for most effective cleaning.

Section 7: APPLICATION

7.1 Introduction. This section provides general information on paint application and on activities associated with application such as paint storage and mixing. Application procedures discussed include brushing, rolling, and spraying (conventional air, airless, air-assisted airless, high-volume low-pressure, electrostatic, plural component, thermal, and powder).

7.2 Paint Storage Prior to Application. The installation industrial hygienist should be consulted about local regulations for paint storage, since storage of paint may be subject to hazardous product regulations. To prevent premature failure of paint material and to minimize fire hazard, paints must be stored in warm, dry, well ventilated areas. They should not be stored outdoors, exposed to the weather. The storage room or building should be isolated from other work areas. The best temperature range for storage is 50 to 85 degrees F. High temperatures may cause loss of organic solvent or premature spoilage of water-based paints. Low temperature storage causes solvent-borne coatings to increase in viscosity, and freezing can damage latex paints and may cause containers to bulge or burst. (When paint is cold, a 24-hour conditioning at higher temperatures is recommended prior to use.) Poor ventilation of the storage area may cause excessive accumulation of toxic and/or combustible vapors. Excessive dampness in the storage area can cause labels to deteriorate and cans to corrode. Can labels should be kept intact before use and free of paint after opening so that the contents can readily be identified.

The paint should never be allowed to exceed its shelf life (normally 1 year from manufacture) before use. The stock should be arranged, so that the first paint received is the first paint used. Paint that has been stored for a long period of time should be checked for quality and dry time before use. Quality inspection procedures are described in par. 9.5.5.

7.3 Preparing Paint for Application

7.3.1 Mixing. During storage, heavy pigments tend to settle to the bottom of a paint can. Prior to application, the paint must be thoroughly mixed to obtain a uniform composition. Pigment lumps or caked pigment must be broken up and completely redispersed in the vehicle. Incomplete mixing results in a change of the formulation that may cause incomplete curing and inferior film properties. However, caution must be used not to

overmix waterborne paints since excessive foam can be created. Constant mixing may be required during application for paints with heavy pigments, such as inorganic zincs.

Mixing can be done either manually or mechanically. Two types of mechanical mixers are commonly used: ones which vibrate and ones which stir with a propeller. Since manual mixing is usually less efficient than mechanical mixing, paints should only be manually mixed when little mixing is needed because there is limited pigment settling or when mechanical mixing is not possible. Vibrator-type mixers should not be used with partly full cans of paint. This can cause air to become entrained in the paint which, if applied, may lead to pinholes in the dry film.

When pigments form a rather hard layer on the bottom of the can, the upper portion of the settled paint can be poured into a clean container (Figure 7), so that the settled pigment can more easily be broken up and redispersed to form a smooth uniform thin paste. When mixing manually, lumps may be broken up by pressing them against the wall of the can. It is essential that settled pigments be lifted from the bottom of the can and redispersed into the liquid. Once the material is uniform, the thin upper portion of the container is slowly poured into the uniform paste while the paint is stirred. Stirring is continued until the entire contents is uniform in appearance. No more paint should be mixed than can be applied in the same day. Paint should not be allowed to remain in open containers overnight.

7.3.1.1 Mixing Two-Component Coatings. Epoxies and polyurethanes are commonly used two-component coatings. The base component, A, contains the pigment, if any. The B component contains the curing agent. The two components must be mixed in the ratio specified by the coating manufacturer on the technical data sheet, unless the coating is being applied using a plural component gun (refer to par. 7.5.4.5). Usually the materials are supplied so that the contents of one can of component A is mixed with the contents of one can of component B. Failure to mix the components in the proper ratio will likely result in poor film formation. Binder molecules are cross-linked in a chemical reaction upon mixing of the two components. Unless the two components are mixed together, there will be no chemical reaction and no curing of the paint.

a) Mixing. Two-component coatings are preferably mixed with a mechanical stirrer as follows:

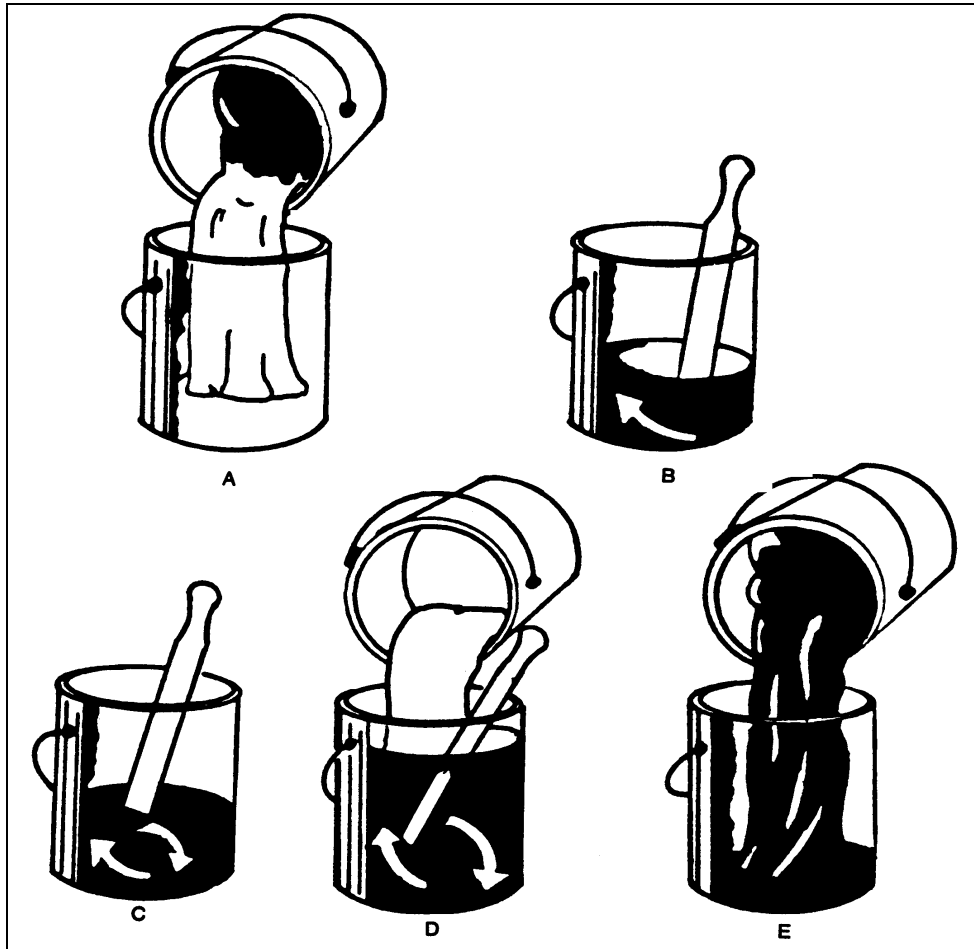

Figure 7
Illustration of Mixing and "Boxing" One-Component Paint: A -
Pouring Off Pigment-Poor Vehicle, B and C - Mixing Pigment
to Form Smooth Paste, D - Pouring in Vehicle and Mixing,
E - Boxing Paint

(1) The base component is mixed to disperse settled pigment. If necessary, some of the thin, upper portion may be poured off before stirring to make it easier to disperse the pigment. When the upper portion is poured off, it must be mixed back with the bottom portion before the two components are mixed together.

(2) While continuing to stir, the two components are slowly mixed together. No more than a few gallons should be mixed at a time, or no more than that specified by the coating manufacturer, since heat is usually generated upon mixing because of the chemical cross-linking reaction. Excessive heat may lead to premature curing of the coating, reducing the pot life.

(3) The two combined parts are agitated until they are of smooth consistency and of uniform color. (Often the color of the two components is different.)

b) Induction. Some two-component paints must stand for approximately 30 minutes after mixing before application. This time is called the induction time. During induction, the chemical reaction proceeds to such an extent that the paint can be successfully applied. However, some formulations of two-component paints do not require any induction time and can be applied immediately after mixing the two components. Material specifications and manufacturer's recommendations must be followed carefully. Induction time will depend on temperature of the paint.

c) Pot Life. Pot life is the time interval after mixing in which a two-component paint can be satisfactorily applied. Paints low in VOC content often have a reduced pot life. The chemical reaction that occurs when two component paints are mixed accelerates with increasing temperature. Thus, a paint's pot life decreases as the temperature increases. Above 90 degrees F, the pot life can be very short. (Curing time of the applied coating is also faster at higher temperatures.) Pot life is also affected by the size of the batch mixed, because the chemical reaction produces heat. The larger the batch, the more the heat produced and the faster the curing reaction proceeds. Thus, the shorter the pot life. Paint must be applied within the pot life. The coating manufacturer's recommendations must be followed carefully. Mixed two-component paint remaining at the end of a shift cannot be reused and must be discarded. Lines, spray pots, and spray guns must be cleaned during the pot life of the paint.

7.3.2 Thinning. Usually thinning to change the viscosity of liquid paint should not be necessary. A manufacturer formulates paint to have the proper viscosity for application. If thinning is necessary, it must be done using a thinner recommended by the coating manufacturer. Also, the amount used should not exceed that recommended by the coating manufacturer. Prior to adding the thinner, the temperature of the coating and the thinner should be about the same. The thinner must be thoroughly mixed into the paint to form a homogeneous material. Some "false-bodied" or "thixotropic" paints are formulated to reach the proper application viscosity after stirring or during brush or roller application. Undisturbed in the can, they appear gel like, but upon stirring or under the high shear of brush or roller application, these materials flow readily to form smooth films. Upon standing, the coating in the can will again become gel-like. Because of this property, thixotropic coatings may require constant agitation during spray application.

7.3.3 Tinting. Tinting should be avoided as a general practice. If materials are tinted, the appropriate tint base (e.g., light and deep tones) must be used. Addition of excessive tinting material may cause a mottled appearance or degrade the film properties (e.g., adhesion). Also, tinting should only be done with colorants (tints) known to be compatible with the base paint. No more than 4 ounces of tint should be added per gallon of paint.

7.3.4 Straining. Usually, paint in freshly opened containers should not require straining. However, mixed paint having large particles or lumps must be strained to prevent the film from having an unacceptable appearance or clogging spray equipment. Straining is especially important for inorganic zinc coatings. Straining is done after mixing, thinning, and tinting is completed by putting the paint through a fine sieve (80 mesh) or a commercial paint strainer.

7.4 Weather Conditions Affecting Application of Paints. Paint application is a critical part of a complete paint system. Many of the newer paints are more sensitive to poor application procedures and environmental conditions than oil paints. Four main weather conditions must be taken into account before applying coatings: temperature, humidity, wind, and rain or moisture. The paint manufacturer's technical data sheets should be consulted to determine the limits for these conditions as well as other constraints on application of the paint. Applying paints outside the limits is likely to lead to premature coating failure.

7.4.1 Temperature. Most paints should be applied when the ambient and surface temperature is between 45 degrees F and 90 degrees F. Lacquer coatings such as vinyls and chlorinated rubbers, can be applied at temperatures as low as 35 degrees F. There are other special coatings that can be applied at temperatures below 32 degrees F but only in strict compliance with manufacturer's instructions. Application of paints in hot weather may also cause unacceptable films. For example, vinyls may have excessive dry spray and latex paints may dry before proper coalescence, resulting in mud-cracking. In all cases painting must be done within the manufacturer's acceptable range. Also, the temperature of the paint material should be at least as high as the surface being painted. Paint should not be applied when the temperature is expected to drop below 40 degrees F before the paint has dried (except when allowed in the manufacturer's instructions).

7.4.2 Humidity. Ensuring the proper relative humidity during application and cure can be essential for good film performance. However, different types of coatings require different relative humidities. The coating manufacturer's technical data sheet should be consulted. Some coatings cure by reacting with moisture from the air (e.g., moisture-curing polyurethanes, silicones, and inorganic zincs). These coatings require a minimum humidity to cure. However, too high a humidity may cause moisture-curing coatings to cure too quickly resulting in a poorer film. In addition, too high a humidity may cause blushing (whitish cast on surface of dry film) of some solvent-borne coatings. Blushing is caused when the surface of a coating film is cooled by evaporation of a solvent to such an extent that water condenses on the still wet film. Excessive humidity may also cause poor coalescence of latex coatings since the coalescing agent may evaporate before enough water evaporates to cause coalescence of the film.

7.4.3 Wind. Wind can cause a number of problems during spray application. These include uncontrollable and undesirable overspray and dry spray caused by too fast evaporation of the solvents. The wind velocity at which these undesirable effects occur depends upon the material being applied and the application parameters. Wind can also blow dust and dirt onto a wet surface which could lead to future paint breakdown.

7.4.4 Moisture. Paint should not be applied in rain, wind, snow, fog, or mist, or when the surface temperature is less than 5 degrees F above the dew point. Water on the surface being painted will prevent good adhesion.

7.5 Methods of Application. The most common methods of application are brush, roller, and spray. They are discussed in detail below. Paint mitts are recommended only for hard to reach or odd-shaped objects such as pipes and railings when spraying is not feasible. This is because it is not possible to obtain a uniform film that is free of thin spots with mitt application. Foam applicators are useful for touch-up or trim work. Dip and flow coat methods are beyond the scope of this handbook. Of the three primary methods, brushing is the slowest, rolling is faster, and spraying is usually the fastest of all. A comparison of approximate rates of application by one painter of the same paint to flat areas is listed in Table 10.

Table 10
Approximate Rates of Paint Application
(From SSPC Good Painting Practice)

Method	Square Feet Applied in 8 Hour Day
Brush	800 - 1400
Roller	2000 - 4000
Air Spray	4000 - 8000
Airless Spray	8000 - 12,000

7.5.1 Selection of Application Method. The choice of an application method depends on the type of coating, the type of surface, environmental factors, and cleanup. Alkyd coatings can easily be applied by brush, but fast drying coatings, such as vinyls, are difficult to apply by brush or roller. Brushing is the preferred method for small areas and uneven or porous surfaces, while rolling is practical on large flat areas. Also, brushing of primers over rusted steel and dusty concrete is preferred over spraying. (Note that applying paint over these substrates should be avoided, if possible.) Spraying is usually preferred on large areas and is not limited to flat surfaces. Spraying may not be feasible in some locations and in some environments because of the accumulation of toxic and flammable fumes or overspray.

7.5.2 Brush Application. Brushing is an effective method of paint application for small areas, edges, corners, and for applying primers. Brush application of primers works the paint into pores and surface irregularities, providing good penetration and coverage. Because brushing is slow, usually it is used only for small areas or where overspray may be a serious problem. Brush application of paint may leave brush marks with paints that do not level well, thus creating areas of low film thickness.

Even a second coat of paint may leave the total coating system with thin and uneven areas that may lead to premature failure.

Brushes are made with either natural or synthetic bristles. A drawing of a typical paint brush is shown in Figure 8. Chinese hog bristles represent the finest of the natural bristles because of their durability and resiliency. Hog bristles are also naturally "flagged" or split at the ends. This permits more paint to be carried on the brush and leaves finer brush marks on the applied coating. Horsehair bristles are used in cheaper brushes but are an unsatisfactory substitute for hog hair. Nylon and polyester are used in synthetic bristles or filaments. The ends are flagged by splitting the filament tips. Synthetic bristles absorb less water than natural bristles and are preferred for applying latex paints. However, synthetic bristles may be softened by strong solvents in some paints. Thus, natural bristles are preferred for application of paints with strong solvents.

Brushes are available in many types, sizes, and qualities to meet the needs for different substrates. These types include wall, sash and trim (may be chisel or slash-shaped), and enamel (bristles are shorter). It is important to use high quality brushes and keep them clean. Brushes with horsehair or with filaments that are not flagged should be avoided. The brush should be tapered from side to center (see Figure 8).

7.5.2.1 Procedure for Brush Application

a) Shake loose any unattached brush bristles by spinning the brush between the palms of the hand and remove the loose bristles.

b) Dip the brush to cover one-half of the bristle length with paint. Remove excess paint on the brush by gently tapping it against the side of the can.

c) Hold the brush at an angle of about 75 degrees to the surface. Make several light strokes to transfer the paint to the surface. Spread the paint evenly and uniformly. Do not press down hard but use a light touch to minimize brush marks. If there is time before the paint sets up, cross-brush lightly to eliminate excessive brush marks.

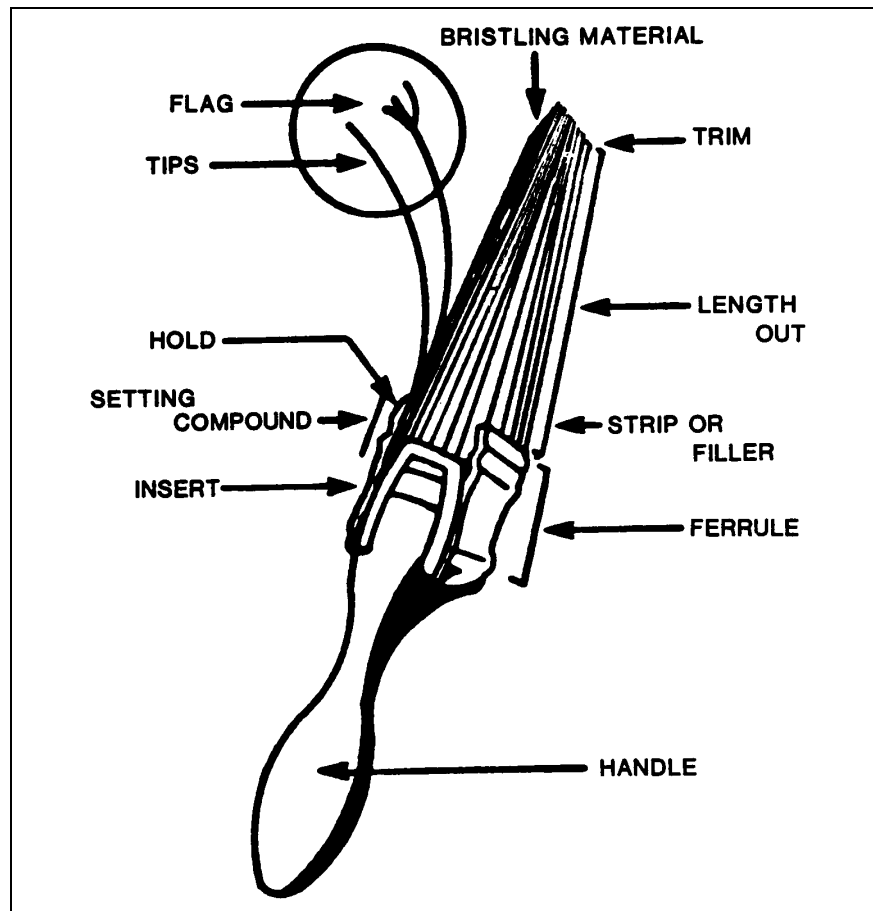

Figure 8
Illustration of Parts of Paint Brush

d) Confine painting to one area so that a "wet edge" is always maintained. Apply paint to a surface adjacent to the freshly painted surface sweeping the brush into the wet edge of the painted surface. This helps to eliminate lap marks and provides a more even coating film.

7.5.3 Roller Application. Roller application is an efficient method for flat areas where the stippled appearance of the dry film is acceptable. However, paint penetration and wetting of difficult surfaces is better accomplished by brush than roller application. Thus, brush application of primers is preferred over roller application.

A paint roller consists of a cylindrical sleeve or cover which slips onto a rotatable cage to which a handle is attached. The covers vary in length from 1 to 18 inches and the diameter from 1.5 to 2.25 inches. A 9-inch length, 1.5-inch diameter roller, is common. The covers are usually made of lamb's wool, mohair, or synthetic fibers. The nap (length of fiber) can vary from 0.25 to 1.25 inches. Longer fibers hold more paint but do not give as smooth a finish. Thus, they are used on rougher surfaces and chain link fence, while the shorter fibers are used on smooth surfaces. Use of extension handles makes the application of paint to higher surfaces easier. However, use of a long extension handle usually results in a less uniform film. Use a natural fiber roller (for example, wool-mohair) for solvent base paints and a synthetic fiber roller for latex paints.

7.5.3.1 Procedures for Roller Application. Rollers are used with a tray which holds the coating or a grid placed in a 5-gallon can (Figure 9). Application procedure is described below.

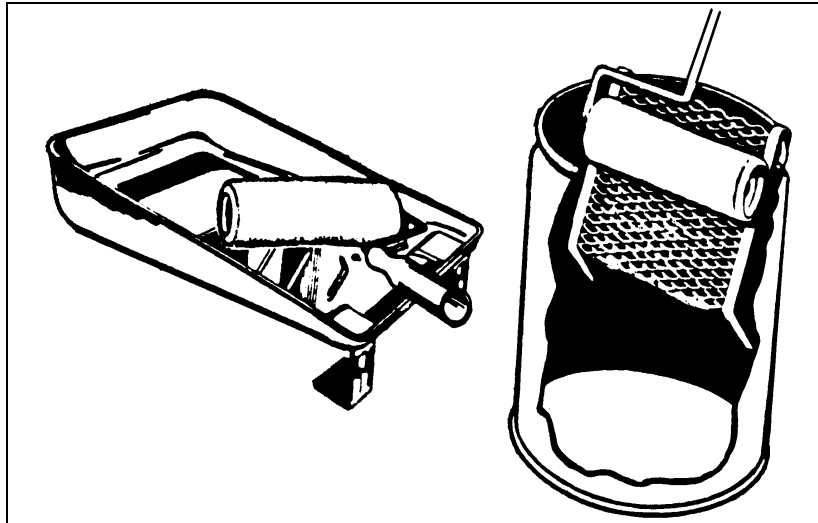

Figure 9
Equipment Used in Applying Paint by Roller

a) If a tray is being used, fill it half full with premixed paint. If a grid or screen is being used, place it at an angle in the can containing premixed paint.

b) Immerse the roller completely in the paint and remove the excess by moving the roller back on the tray or grid. Skidding or tracking may occur if the roller is loaded with too much paint.

c) Apply the paint to the surface by placing the roller against the surface forming a "V" or "W" of a size that will define the boundaries of the area that can be covered with the paint on a loaded roller. Then roll out the paint to fill in the square area. Roll with a light touch and medium speed. Avoid letting the roller spin at the end of a stroke. Always work from a dry adjacent surface to a wet surface. The wet edge should be prevented from drying to minimize lap marks.

d) Use a brush or foam applicator to apply paint in corners, edges, and moldings before rolling paint on the adjacent areas.

7.5.4 Spray Application. Spray application is the fastest technique for applying paint to large areas. Spray application also results in a smoother, more uniform surface than brushing or rolling. There are several types of equipment: conventional air, airless, air-assisted airless, high-volume, low-pressure (HVLP), electrostatic, multi-component, thermal, and powder. Conventional air and airless were most commonly used. However, with changing VOC requirements the other methods are being used more. Air or air-assisted methods of spraying, including HVLP, rely on air for paint atomization. Jets of compressed air are introduced into the stream of paint at the nozzle. The air jets break the paint stream into tiny particles that are carried to the surface on a current of air. The delivery of the paint to the nozzle may be assisted using hydraulic pressure. In airless spray, paint is forced through a very small nozzle opening at very high pressure to break the exiting paint into tiny droplets. A general comparison of properties of conventional air and airless spray are given in Table 11. Note that specific application rates, the amount of overspray, and other properties depend to a great extent upon the type of paint, and may vary from those listed in the table. Air methods other than conventional have been developed to overcome some of the environmental and other concerns of air and airless spray. These differences are discussed separately for each method below.

7.5.4.1 Conventional or Air Spray Equipment. The conventional method of spray application is based on air atomization of the paint. The basic equipment (air compressor, paint tank, hoses for air and paint, spray gun) is shown in Figure 10. The coating material is placed in a closed tank (sometimes called a pot) connected to the nozzle by a hose and put under regulated

pressure using air from the compressor. A hose from the air compressor to the nozzle supplies the air required for atomization of the paint. The tank may be equipped with an agitator for continuously mixing paints with heavy pigments. The air compressor must have sufficient capacity to maintain adequate and constant air pressure and airflow for paint atomization at the nozzle, for paint flow from the tank to the nozzle, for powering the agitator and other job-site requirements. A constant flow of air from the compressor is required for proper painting. Loss of pressure at the nozzle can cause pulsating delivery of the paint as opposed to the desired constant flow. (Data sheets from paint manufacturers give recommended air pressures for spraying.)

a) Air Hose. The air hose connecting the compressor to the tank must be of sufficient diameter to maintain adequate air pressure. Required diameter of the fluid hose connecting the gun and tank depends on volume and pressure of paint required at the gun. The hose should be kept as short as possible, especially when spraying coatings with heavy pigments, to avoid settling of pigments within the supply hose. Also, the fluid hose must be resistant to paints and solvents that flow through it. As with blasting equipment, the air supply must be free of moisture, oil, and other impurities. Oil and water should be removed by separator or extractor attachments to the compressor.

Table 11
Comparison of Conventional Air and Airless Spray

Property	Conventional Air	Airless
Coverage, sq ft/day	4-8000	6-10,000
Overspray	Considerable	Some
Transfer efficiency	Poor (about 30	Fair (35-50)
"Bounce back"	percent)	Minor
Hoses	Significant	1 (fluid)
Penetration of corners, crevices and cracks	2 (air and fluid)	Moderate
Film build per coat	Fair	Good
Versatility	Fair	Fair
Paint clogging problems	Good	More
Operator control	Few	Poor
Safety during painting	Good	Poor
Safety during cleanup	Fair	Poor
	Fair	

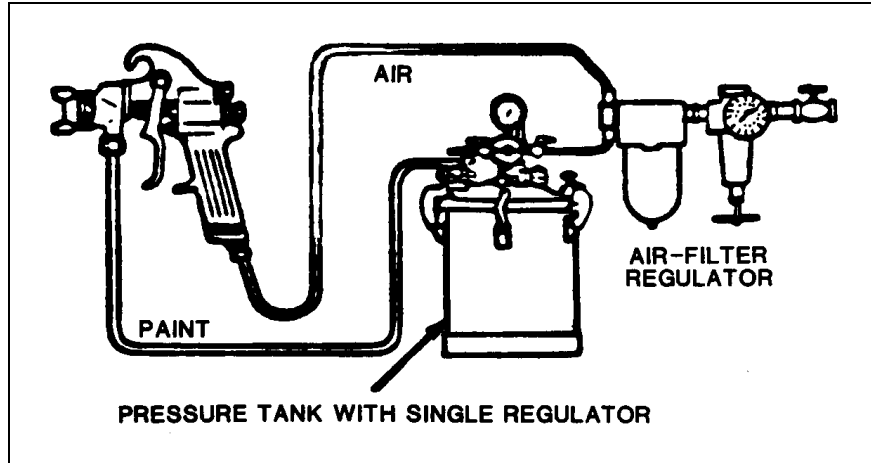

Figure 10
Schematic Drawing Illustrating Basic Parts of Conventional
Air Spray Application Equipment

b) Gun or Nozzle. The gun or nozzle is a relatively complex device (Figure 11). It consists basically of 10 parts:

(1) Air nozzle or cap that directs the compressed air into the stream of paint to atomize it and carry it to the surface.

(2) Fluid nozzle that regulates the amount of paint released and directs it into the stream of compressed air.

(3) Fluid needle that controls the flow of fluid through the nozzle.

(4) Trigger that operates the air valve and fluid needle.

(5) Fluid adjustment screw that controls the fluid needle and adjusts the volume of paint that reaches the fluid tip.

(6) Air valve that controls the rate of airflow through the gun.

(7) Side port control that regulates the supply of air to the air nozzle and determines the size and shape of the spray pattern.

(8) Gun body and handle designed for easy handling.

(9) Air inlet from the air hose.

(10) Fluid inlet from fluid hose.

c) Air Nozzle. Two general types of air nozzles are available: external atomization and internal atomization. In both types, outer jets of air atomize the wet paint (see Figure 12). In the external type, paint is atomized outside the nozzle, while in the internal type paint is atomized just inside the nozzle opening. The type selected depends on the type of paint to be sprayed and the volume of air available. The external type is the more widely used. It can be used with paints and most production work. The spray pattern can be adjusted. A fine mist can be obtained which can result in a smooth even finish. Nozzle wear and buildup of dry material are not major problems. The internal-mix air nozzle requires a smaller volume of air and produces less overspray and rebound than the external type. The size and shape of the spray pattern of the internal-mix nozzle cannot be adjusted. Catalyzed and fast drying paints tend to clog the openings of internal-air nozzles. These coatings should be sprayed with an external-mix nozzle.

d) Setting-Up, Adjusting Equipment, and Shutting-Down Procedures. Both the pressure on the paint and the air pressure at the gun must be properly regulated to obtain the optimum in film performance. A properly adjusted nozzle will produce a fan that is about 8 inches wide, 10 inches from the gun. The shape of the spray pattern produced may vary from round to oval. The pattern must have well defined edges with no dry spray at the ends or heavy film buildup in the middle (Figure 13). Coating manufacturers provide guidance on appropriate equipment and pressures for application of their coatings. Additional job-site adjustments may be necessary. The aim is to obtain a wet looking film that is properly atomized with as little overspray as possible. To minimize bounce back and dry spray, the atomizing air pressure should be kept as low as possible. Common spray pattern problems and their cause and remedy are listed in Table 12. The gun should be taken apart and cleaned at the end of each day and the air cap and fluid tip should be cleaned with solvent. Pivot points and packing should be lubricated with lightweight oil. Leaving a gun in a bucket of solvent overnight will likely cause the gun to become plugged and lead to premature failure of the gun. The shutting-down procedure is detailed in the instructions supplied by the manufacturer of the spray equipment and these instructions should be followed. Other worker safety issues are discussed in the section on safety.

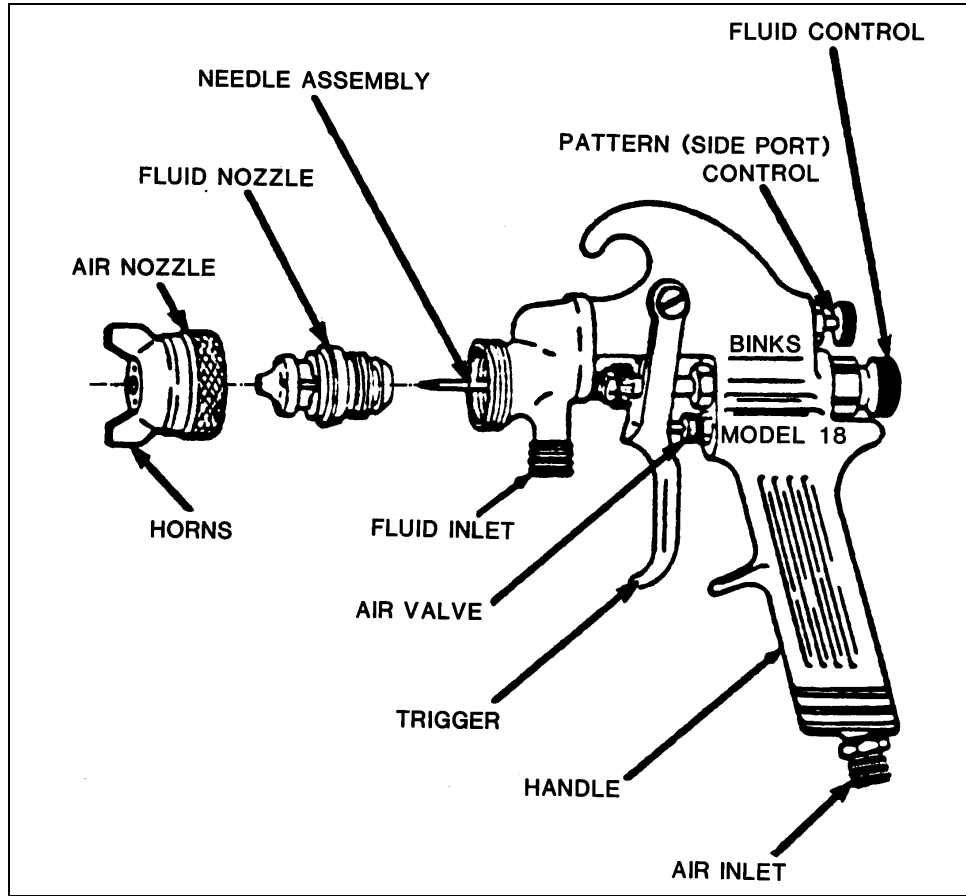

Figure 11
Drawing of Air-Spray Gun

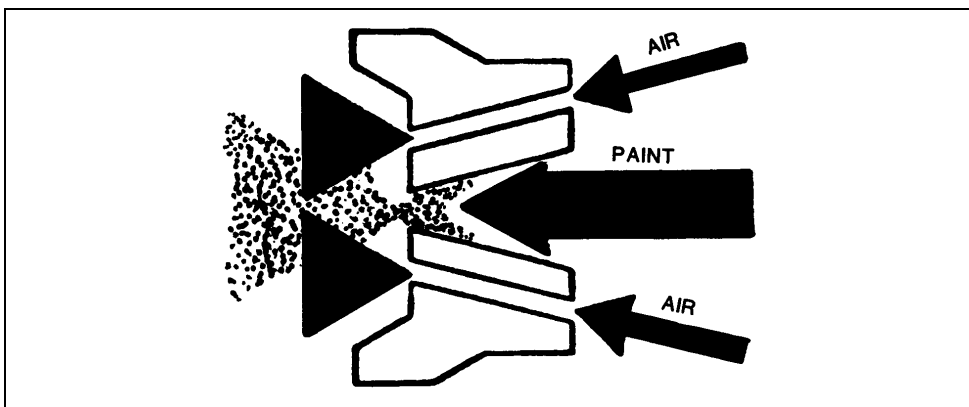

Figure 12
Cross-Sectional Drawing of Nozzle of Air-Spray Gun

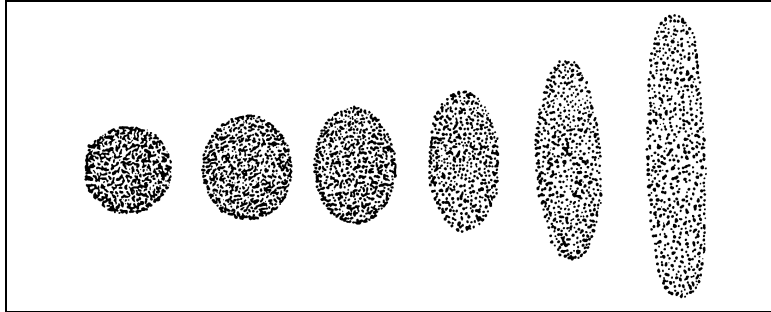





Figure 13
 Illustration of Proper Spray Patterns
 (Note that the patterns are uniform throughout.)

Table 12
 Common Conventional Air-Spray Problems and Their Causes
 and Remedies

	Description	Cause	Remedy
	Thick center; thin ends; pinholes	Atomizing air pressure too low; too much fluid to gun	Increase air pressure; decrease fluid pressure or use smaller nozzle
	Hourglass shape; dry spray on ends	Fluid pressure low; air pressure too high; too wide a spray pattern	Increase fluid pressure; reduce air pressure; adjust pattern control; reduce paint viscosity
	Teardrop shape; thicker at bottom	Problem with gun - nick in needle seat; partially clogged orifice or slightly bent needle or loose nozzle	Remove and clean air nozzle; replace any bent parts or tighten air nozzle
	"Boomerang"	Dried paint has clogged one of the side port holes of the air nozzle	Dissolve dried paint with thinner; do not probe into nozzle with metal devices





7.5.4.2 Airless Spray

a) Equipment. Airless spray relies on hydraulic pressure alone. Atomization of paint is accomplished by forcing the material through a specially shaped orifice at pressures between 1000 and 3000 psi. Because of the high pressures, extreme care must be taken to prevent worker injury. The spray manufacturer's instructions must be followed carefully. The basic parts of airless spray equipment are a high-pressure paint pump, a fluid hose, and an airless spray gun. The high-pressure pump must deliver sufficient pressure and material flow to produce a continuous spray of paint. The fluid hose must be able to withstand the very high pressures required to deliver the paint to the gun and atomize it. A filter screens out particles that might clog the tip. Since atomization is controlled by the size and shape of the orifice of the tip, a different tip is used to obtain different patterns and atomization rates. The tip angle controls the fan width. Tips having the same orifice size but different angles deliver the same amount of paint, but the area covered with one pass is different. Viscous materials require a larger tip than less viscous materials. Coating manufacturers recommend tip sizes on their data sheets. The larger the orifice, the greater the production rate. But, if too large an orifice is used for a thin coating, the rate of delivery may be such that the operator cannot keep up with the flow. This will result in sagging and running of wet paint. Airless spray is available with heaters to reduce paint viscosity, permitting spraying of coatings having higher ambient viscosities at a faster production rate.

b) Setting-Up, Adjusting Equipment, and Shutting-Down Procedures. The manufacturer's instructions should be followed for setting up the spray equipment. To minimize tip clogging problems, airless spray equipment must be scrupulously clean before setting-up for a spray application and the coating must be free of lumps. The manufacturer's recommendations should be followed rigorously for the setting-up, using, and shutting-down procedures. Since the pressures used are high, two safety features are required for guns: a tip guard and a trigger lock. The tip guard prevents the operator from placing a finger close to the tip and injecting paint into the skin. The trigger lock prevents the trigger from accidentally being depressed. Other safety measures include never pointing the gun at any part of the body; not making adjustments without first shutting off the pump and releasing the pressure; making sure the fluid hose is in good condition, free of kinks, and bent into a tight radius; and using only high-pressure hose fittings. Also, never clean systems containing aluminum with chlorinated solvents. Explosions may occur. Causes of and remedies for faulty patterns are described

in Table 13. Additional problems that may occur with airless spraying may be associated with excessive pressure, undersized equipment, and too long or too small paint hoses. Undersized spray equipment, including hoses, may result in lower production rates, a pebbly-appearing film caused by poor atomization (nozzle tip too large), and thin films. Air supply hoses that are too long or too small may cause instability of the pump, poor atomization of the paint, or a pulsating spray pattern.

Table 13
Common Airless-Spray Problems and Their Causes and Remedies

	Remedy	Description	Cause
	Thick center, pressure, thin ends, pinholes and hour-glass shape	Inadequate fluid delivery or improper atomization	Increase fluid decrease paint viscosity, choose larger tip orifice, or reduce number of guns using one pump
	Teardrop shape replace coating thicker	Clogged or worn nozzle tip if necessary	Clean nozzle tip,
	Rippling, uneven pattern	Pulsating fluid delivery or suction leak	Increase supply to air motor, reduce number of guns using one pump, choose smaller tip orifice, clean tip screen and filter, or look for hose leak
	Round pattern	Worn nozzle tip or fluid too viscous for tip size	Replace worn tip, decrease fluid viscosity increase pressure, or choose correct tip orifice
	Fluid spitting	Air entering system, dirty gun, or wrong cartridge adjustment	Check for hose leak, clean gun, or adjust cartridge and replace if necessary

7.5.4.3 Air-Assisted Airless Spray. Air-assisted airless spray uses air to help atomize paint as compared with only fluid pressure in the airless system. Thus, a lower hydraulic pressure (typically 500 to 1000 psi) can be used. Air pressure is typically 10 to 15 psi. Air-assisted airless spray provides a finer spray than airless spray, and the lower hydraulic pressure provides improved operator control. Consequently, finishes tend to be smoother with fewer runs and sags. Transfer efficiency is about the same as airless spray, but air-assisted airless spray is more expensive to maintain.

7.5.4.4 High-Volume, Low-Pressure Spray. HVLP spray is an air spray technique that uses low pressure and large volumes of air to atomize the paint. It has much better transfer efficiency than conventional air spray and some systems have been found to meet the 65 percent transfer efficiency requirement of California's South Coast Air Quality District. Because of the lower air pressures, there is also less bounce back than with conventional systems. Turbine air-supply systems, along with large (1-inch diameter) hoses are commonly supplied with the systems. Since the air supply is not turned off when the trigger is released, air flows continuously through a bleeder valve in the gun. An HVLP gun can be equipped with different fluid and air tips depending upon several variables: the desired spray pattern (wide fan to narrow jet), viscosity of the finish, and output of the turbine. Although some special training of painters may be required because of differences between conventional air systems and HVLP, such as less recoil, higher delivery volumes and continuous flow of air, an experienced operator has good control.

Conversion kits for air compressor systems are available which allow the use of them with HVLP systems. Spray techniques may be slightly different depending upon the source of pressurized air.

7.5.4.5 Multi-Component Spray. Multi-component (or plural-component) spray equipment combines components of multi-component paints in the nozzle. The equipment is more complicated than other spray equipment, and its use is usually confined to large or specialized coating applications. The components are metered to the gun in the proper relative volumes, mixed and then atomized by one of the previously described techniques. Thus, pot life is not a factor in application of multi-component coatings. However, it is essential that the metering be done in accordance with the coating manufacturer's instructions. Volume mixing ratios are usually from 1:1 to 1:4. Heating of the components before mixing is also provided with some equipment. By heating the components, both the viscosity during application

and the cure time can be altered. The equipment is cleaned by purging with solvent. Because of the complicated nature of the equipment, specialized operator training and skilled operators are required. Initial and maintenance costs are also greater than for other spray techniques.

7.5.4.6 Electrostatic Spray. In hand-held electrostatic spray systems, a special protruding part of the gun is given a high, negative voltage which places a negative charge on the spray droplets as they come from the gun. The surface being painted is grounded. This causes the paint droplets to be attracted to the grounded surface to be painted. Because there is an electrical attraction between the paint droplets and the object being painted, a very high percentage of droplets lands on the surface. That is, the transfer efficiency is high and there is minimal overspray. Also, some droplets will be attracted to the edges and the back of the surface, if they are accessible. This is called the wraparound effect. Specially formulated paints are required for electrostatic spraying. Also, painting is restricted to use on conductive substrates, such as steel or galvanized steel. Only one coat of paint may be applied to the base metal by electrostatic spraying since a painted surface is not conductive. Electrostatic spray is an ideal spraying method for piping, fencing, channels, and cables because of the wraparound effect and minimal overspray. However, because of high voltage, special safety requirements must be met, including grounding the power supply and the operator.

7.5.4.7 Powder Spraying. Powder coatings, usually epoxies, are specially prepared polymeric coatings. They are applied to preheated conductive surfaces, such as steel, by special electrostatic spray equipment or in a fluidized bed. Once applied, the coated component is heated to fuse the powder into a continuous coating film. This technique is commonly used in shop applications because heating can be done in an oven, there are no volatile solvents to control and material that did not stick to the surface can be collected and reused. Portable systems are also available and can be used in special situations.

7.5.4.8 Thermal Spraying. Thermal spraying, sometimes called metallizing, is a process in which finely divided metals are deposited in a molten or nearly molten condition to form a coating, usually on steel. Equipment and techniques are available for flame or electric arc spraying of pure zinc, pure aluminum, or an 85 percent zinc, 15 percent aluminum alloy. The coating material is available in the form of a powder or wire, with wire used more frequently. Once the metal becomes molten, it is delivered to the surface with air or gas pressure. It forms a porous coating that protects steel by cathodic protection

in a variety of environments. For more severe service such as very acid or alkaline conditions, or fresh or salt water spray, splash, or immersion, the coating may be sealed with a thin conventional organic coating or silicone. A white-metal blasted surface is required. Metal spray coatings are normally very abrasion resistant and provide excellent corrosion control.

Thermal spraying of metals is best accomplished in a shop environment, but can also be done in the field. DOD-STD-2138(SH) describes the wire flame spraying of aluminum using oxygen-fuel gas. SSPC Guide 23, Coating Systems describes thermal spray metallic coating systems.

7.5.4.9 Application Technique. Proper application technique is essential for obtaining quality films. Poor technique can result in variations in paint thickness, holidays (small holes), and other film defects, and wasted time and materials. The same basic techniques described below are used for both conventional and airless spraying:

a) Stroking. With the spray gun at a right angle to the work, the wrist, arm, and shoulder are moved at a constant speed parallel to the surface. Holding the gun at an upward or downward angle to the surface will result in a non-uniform coating thickness and may increase the problem with dry spray or overspray. Also, changing the distance between the gun and the surface, arcing, as illustrated in Figure 14, will result in a non-uniform coating thickness. For large flat surfaces, each stroke should overlap the previous one by 50 percent as shown in Figure 15. This produces a relatively uniform coating thickness. The stroke length should be from 18 to 36 inches, depending upon the sprayer's arm length and comfort. Surfaces of greater length should be divided into smaller sections of appropriate length (Figure 16). Each section should slightly overlap the previous one along the lines where they are joined.

b) Triggering. The spray gun should be in motion before triggering and continue briefly after releasing at the end of a stroke. This is illustrated in Figure 17. Proper triggering also keeps the fluid nozzle clean, reduces paint loss, prevents heavy buildup of paint at corners and edges, and prevents runs and sags at the start and end of each stroke.

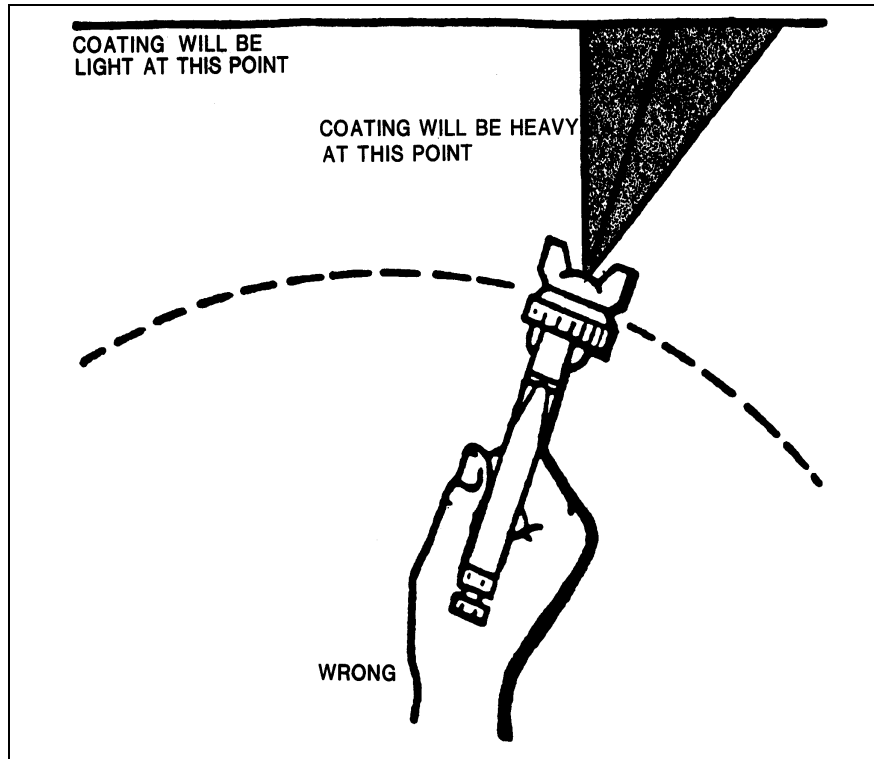

Figure 14
Illustration of Improper Movement of Spray Gun
When Applying Paint

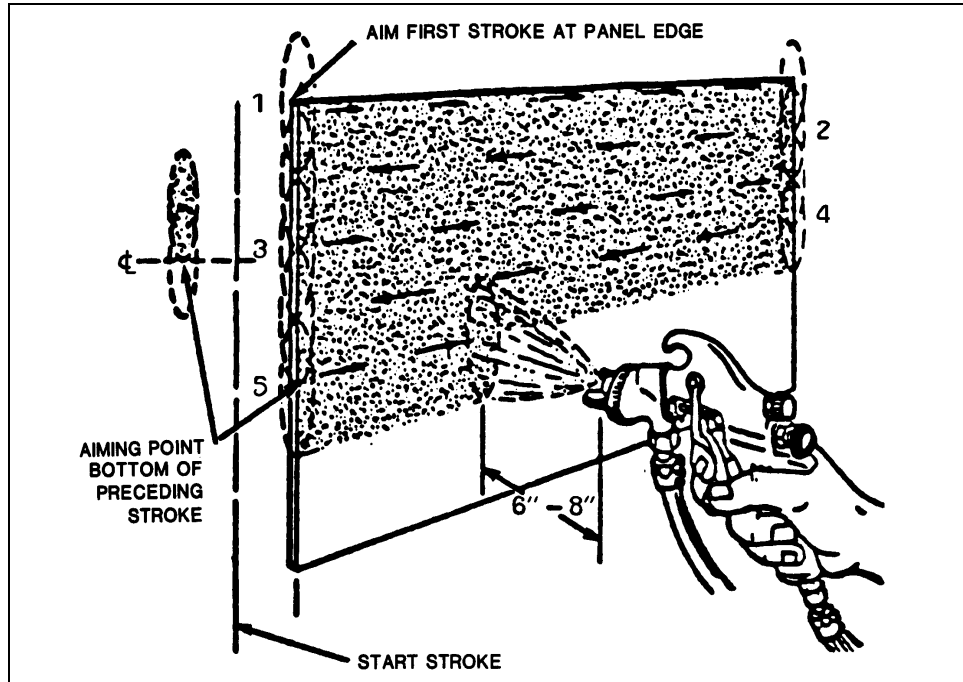

Figure 15
Illustration of Proper Procedure for Spray Painting
Large Flat Surfaces

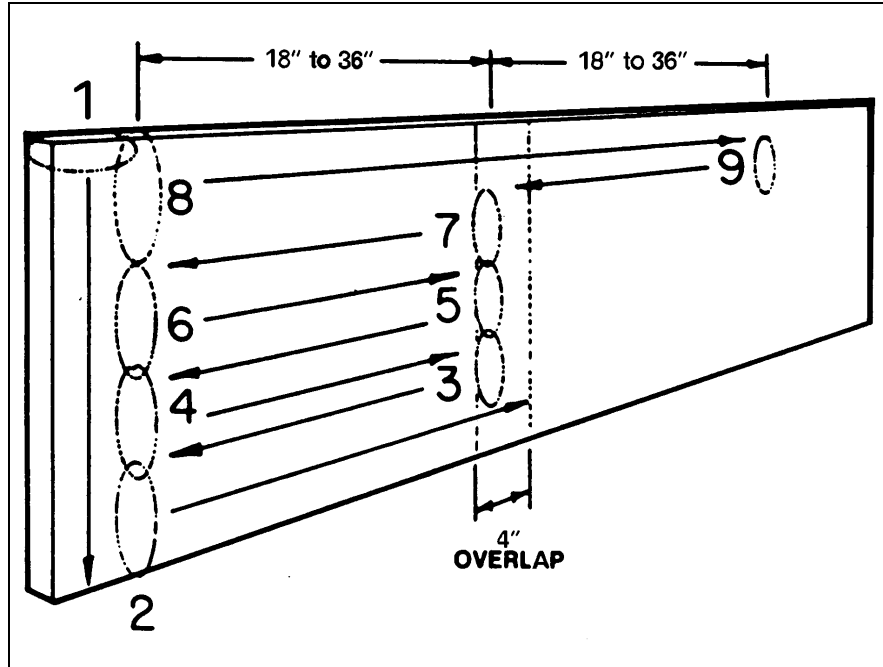

Figure 16
Schematic to Illustrate Proper Painting of Large Vertical
Surfaces

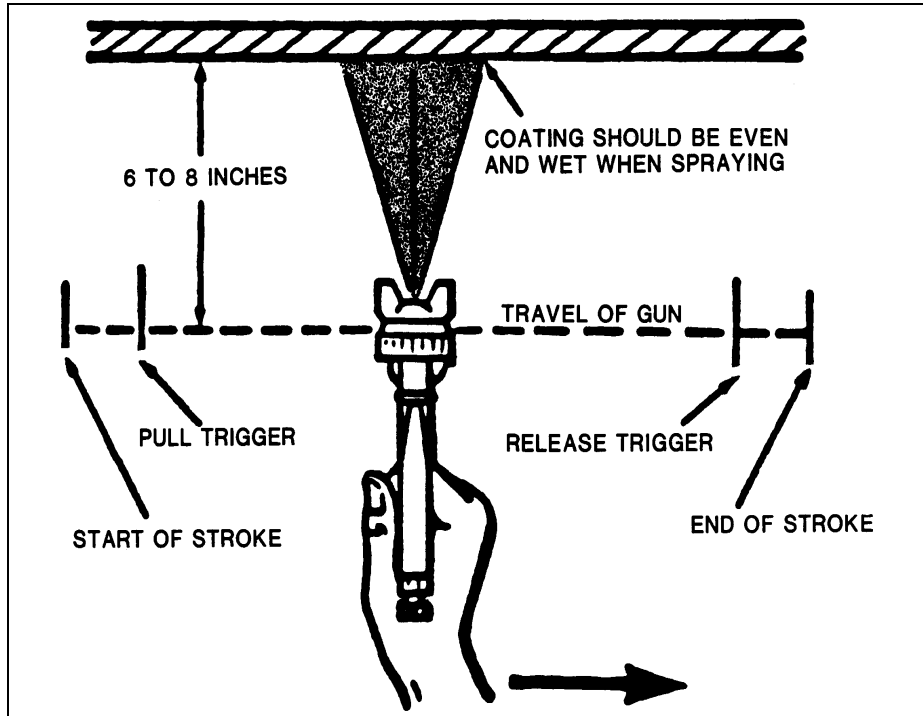

Figure 17
Illustration of Proper "Triggering" of Spray Guns

c) Distance. Distance between the nozzle and the surface being painted depends on atomization pressure and the amount of material delivered. This distance usually varies from 6 to 12 inches for conventional spraying and from 12 to 15 inches for airless spraying. If spray gun is held too close to the surface, heavy paint application and sagging or running may occur. If the gun is held too far away from the surface, a dry spray with a sandy finish may result. Such paint films usually contain holidays (small holes) and provide an unacceptable surface.

d) Corners. Both inside and outside corners require special techniques for uniform film thickness. Each side of an inside corner should be sprayed separately as shown in Figure 18. Too thick a layer of paint can easily be applied to an inside corner. But when too thick a layer is applied, the coating may shrink or pull away from the inside corner causing a void underneath the coating. This will lead to premature failure. An outside corner is first sprayed directly, as shown in Figure 19, and then each side is coated separately. On an outside corner,

the coating tends to pull away from the corner. Thus, the coating on the corner tends to be too thin. Outside edges should be ground so that the edge is rounded before painting.

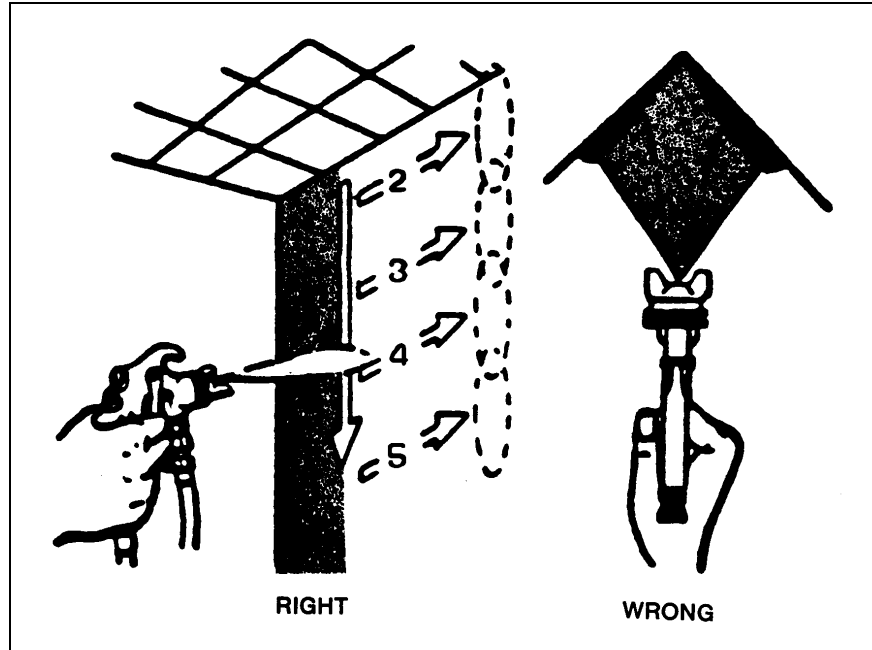

Figure 18
Proper Spray Painting of Inside Corners

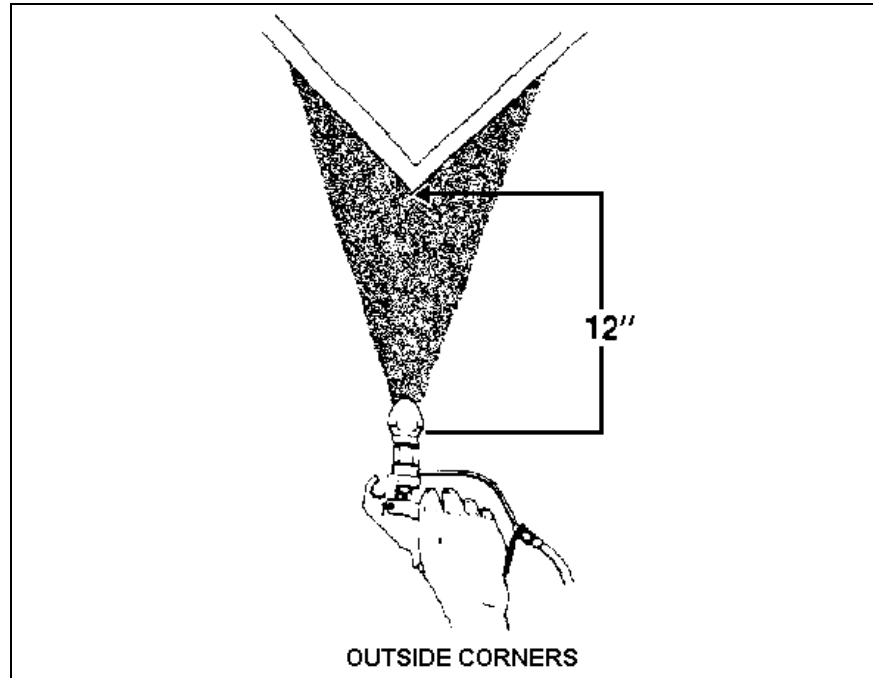

Figure 19
Proper Spray Painting of Outside Corners

e) Welds. Welds are usually rougher than the adjacent steel and a uniform coating is more difficult to achieve. Failure often occurs first over welded areas. Thus, after grinding the welds to smooth them, a coat of paint should be brushed over the welds. Then the entire surface can be painted by spray. With this extra coating over the welds, paint often lasts as long over welds as on the adjacent flat areas.

f) Nuts, Bolts, and Rivets. It is a good coating practice to brush-coat these areas before spraying the flat areas. Paint can be worked into crevice and corner areas. Nuts, rivets, and bolts should be sprayed from at least four different angles to prevent thin coatings caused by shadowing effects (Figure 20).

g) Common Errors. Some common errors and the results that are produced in spray painting are summarized in Table 14.

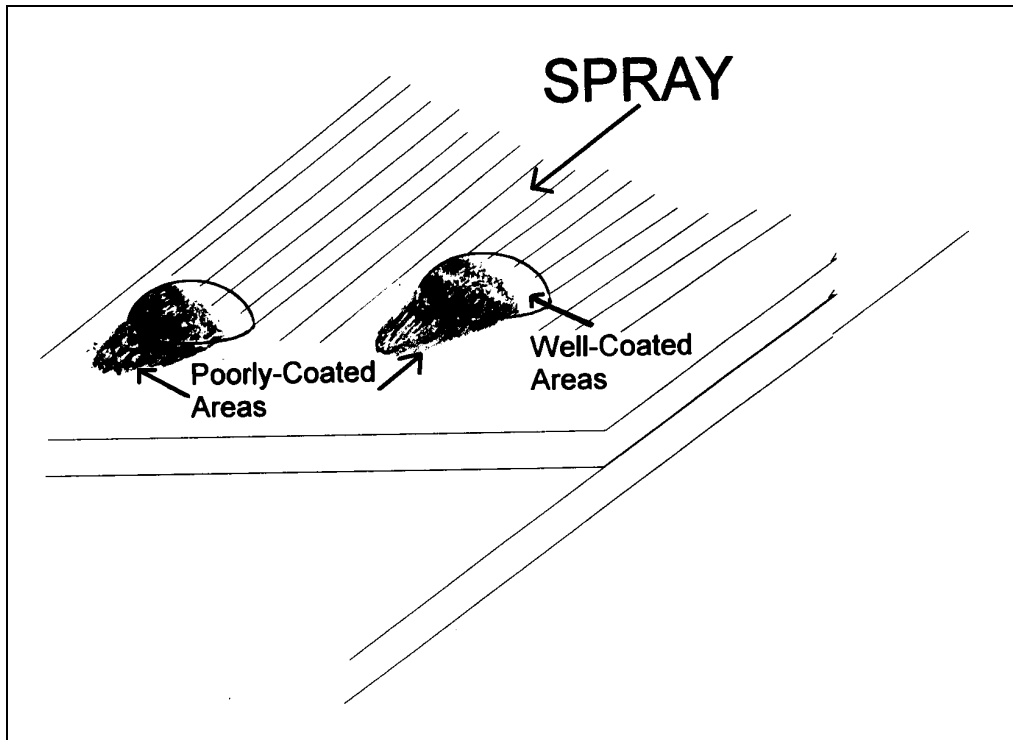

Figure 20
Schematic Illustrating Importance of Spraying Surfaces With
Protruding Parts From All Directions to Avoid "Shadowing Effect"

Table 14
Spray Painting Errors

Error	Result
Improper spraying technique (e.g., arcing, tilting gun)	Spray pattern varied from narrow to wide Variation of sheen from overspray Uneven film thickness
Improper fan width	Inadequate or excessive film build on complex substrate shapes, such as "I" or "H" beams
Spray gun too close to surface	Excessive film build Runs, curtains, sags Poor paint adhesion from improper curing Wrinkling during and after surface curing Excessive paint used Orange peel pattern or blow holes
Spray gun too far from surface	Film build too thin Non-uniform film thickness Dry spray Uneven angular sheen from overspray earlier work

Section 8: PREPARATION OF A PAINTING CONTRACT SPECIFICATION

8.1 General. A contract specification is a written detailed, precise description of the work to be done; it constitutes a part of the overall contract to describe the quality of materials, mode of construction, and the amount of work. The purposes of the specification are:

- a) To obtain a specific desired product
- b) To ensure quality materials and workmanship
- c) To ensure completion of work
- d) To avoid delays and disputes
- e) To obtain minimum or reasonable costs
- f) To make the contract available to as many qualified bidders as possible
- g) To avoid costly change orders and claims
- h) To meet safety, environmental, and legal requirements

Construction specifications provide a description of the desired work in such detail that a product other than that desired may not result. Because painting frequently comprises only a small part of construction work, it frequently receives only limited attention so that it is inadequate to fill the desired goals.

Construction specifications are further complicated by the fact that they comprise legal documents and thus must meet legal as well as technical requirements. Deficiencies in paint or other construction specifications permit bidders to interpret incompletely described requirements to their advantage, and to provide lesser work or cheaper materials. These in turn, give rise to disputes and litigation. Thus, it is extremely important that specifications be prepared systematically, thoroughly, and legally.

8.2 Background. At one time, it was a common practice to use old painting specifications over and over again without attempting to update them. Changes to meet new needs frequently were made by "cutting and pasting." This did not permit the use of new technology, address new requirements, or correct errors in earlier documents.

Another common practice was to have coating suppliers prepare specifications for painting, particularly for small jobs. As might be expected, the supplier's products were required by the document. Today, specifications are usually prepared by architect-engineers who specialize in this work. They have the background, and the standards and other criteria documents at their disposal, to prepare an engineering document for a specific job in a professional manner that is technically correct (complete and without error), clear (unambiguous), and concise (no longer than absolutely necessary).

The specification writer must be able to describe the important details while visualizing the desired final products of the work. The different requirements and phases of the work must be presented in logical, sequential steps to permit the work to be accomplished efficiently. Poorly or incompletely written specifications can result in the following bidding problems: bids from unqualified contractors, fewer bids from qualified contractors, or unrealistically high or low bids.

8.3 The CSI Format. A systematic format for construction specifications is necessary to include important items. It also makes it easier for those preparing bids or executing the contract to accomplish their work, because the requirements can be found in the same part of the document, as in previous documents from the firm. The format of the Construction Specification Institute (CSI) is used by the Federal and many State governments, as well as private industry. It divides construction work into 16 divisions by the building trade involved with the work. Finishes are always in Division 9 and paints and protective coatings in Section 09900 of Division 9. Sections have five digit numbers. Each CSI section is divided into three basic parts:

- a) Part 1. General
- b) Part 2. Products
- c) Part 3. Execution

8.3.1 General Information Part. The general information part of the CSI format includes the following sections:

- a) Summary or Introduction
- b) References
- c) Definitions

- d) Submittals
- e) Quality Assurance
- f) Delivery, Storage, and Handling
- g) Site Conditions

8.3.1.1 Summary Section. A Summary or Introduction section at the start may present the scope and purpose of the work. Care must be taken here to avoid any repetition of work described elsewhere in the document, because any variations in description can result in problems of interpretation. Thus, many specification writers prefer to use only the title of the specification to introduce the document.

8.3.1.2 Reference Section. The reference section, sometimes called "Applicable Documents," includes a listing of documents used in the specification and no others. Others included only for general information may be interpreted as requirements. Listed references form a part of the specification to the extent indicated.

a) Industry specifications and standards, such as those of the SSPC, are preferred to Government standards for equivalent products or processes. Their issuing organization, number, and latest issue are normally listed. Unless otherwise indicated, the issue in effect on the day of invitation for bids applies. Where alternative standards occur, the normal order of precedence is:

- (1) Industry documents
- (2) Commercial item descriptions (CIDs)
- (3) Federal documents
- (4) Military documents

b) This should not be confused with the order in which they are normally sequenced in the specification reference listing - alphabetically, by organization name, or by document category name. For example:

- (ASTM) (1) American Society for Testing and Materials
- (2) Commercial item descriptions

- (3) Federal specifications
- (4) Steel Structures Painting Council (SSPC)

c) Within each of the above categories, individual documents are listed numerically. As with other items, references should be used as little as possible in the body of the specification to minimize error. Where alternative standards or practices are available, only one of them should be used.

8.3.1.3 Definition Section. An understanding of terms used in painting operations may vary widely in different geographical locations and even between different people in the same location. Definitions for such words may prevent costly disputes over different interpretations.

8.3.1.4 Submittals Section. Specification submittals are documents or samples to be provided by the contractor to the contracting officer. They are provided to ensure that specific requirements will be met.

a) Submittals on painting contracts may include:

- (1) Wet samples of coatings
- (2) Drawdown films of coatings
- (3) Blast-cleaned reference panels
- (4) Laboratory test results
- (5) Certificates of conformance
- (6) Product data sheets
- (7) Supplier's instructions
- (8) Supplier's field reports
- (9) Shop drawings
- (10) Warranties

b) Complete laboratory testing of paint for conformance to specification can be very expensive and thus is not often done except where very large areas are coated or where the coating provides a critical function. More often, the contracting officer accepts certificates of conformance. These are basically statements that a previous representative batch of

the same formulation have met specification requirements, and a few quick laboratory tests (standard quality control (QC) tests) by the supplier indicate that the present batch does also. Sometimes, analytical results from an earlier batch are required along with the certificate. When qualified products lists, for Federal or military specifications, or suggested supplier lists, for commercial item descriptions, are available, the listed suppliers should be utilized.

c) For large or critical batches of paint, factory-witnessed manufacture or testing is sometimes done. These and first article tests can be very expensive and so should be used only where the expense is justified.

d) Sometimes, authenticated wet samples of coating are retained for later testing, should early failure occur. They are normally retained for only 1 year, the normal warranty period. The specification should also permit field sampling of coatings being applied. This may prevent unnecessary thinning or substitution of products.

e) The data sheets and instructions of suppliers may be used to define under what conditions and under what acceptable procedures the product can be successfully applied to produce a quality film. If SSPC PA 1, Shop, Field, and Maintenance Painting, or a written description of the work requirements are included in the specification, the order of priority of these documents should be stated, should some differences occur.

f) At one time, many specifications stated that an undercoat should be allowed to thoroughly cure before topcoating. However, complete curing of thermosetting undercoats may present problems of adhesion of finish coats.

g) Warranties should also be received as a submittal. Some products such as textured coatings for masonry structures are commonly warranted for 15 years. Such warranties are normally limited to such conditions as flaking, blistering, or peeling. They do not usually include fading or chalking in sunlight.

h) Inspection, safety, or work sequence and scheduling plans may be required in order to obtain information on how each of these aspects will be handled. An inspection plan will show how each of the inspection requirements will be met. SSPC has examples of these plans and reporting forms. Information of the sequencing and execution of the work will be important where they affect other operations.

8.3.1.5 Quality Assurance Section. The quality assurance section includes those items not covered elsewhere in the general information or execution parts that are necessary to ensure that quality work will be obtained from the contractor.

a) They may include the following:

- (1) Qualifications
- (2) Certifications
- (3) Field sampling
- (4) Regulatory requirements
- (5) Preconstruction conference

b) Qualification or certification statements may be requested to establish the capabilities of the contractors and his employees. This is particularly necessary, if capabilities with high pressures from airless spray or other safety hazards require special certification. The SSPC Painting Contractor Certification Program will ensure the capability of completing the work in a satisfactory manner and time. Additional certification may be required if asbestos fibers or lead-based paint complicate the work. It is desirable to include a clause permitting the contracting officer to procure at any time a sample of the paint being applied. Local air pollution personnel usually have this authority.

c) The contractor must be familiar with prevailing regulations. Material safety data sheets (MSDS) for paints, solvents, and other materials to be used should also be submitted and kept available on-site. In addition, coating manufacturer's technical data sheets should also be on-site and available.

d) A preconstruction conference and site visit of contracting officer and contractor personnel should be held before the work begins. At this time, any differences of opinion or uncertainties should be resolved. Any agreements reached that affect the specification should be written down and signed by both parties so that it becomes a part of the contract. Any differences not resolved may result in costly change orders.

8.3.1.6 Delivery, Storage, Handling, and Disposal. Information must be provided on acceptable methods of delivery, storage, and handling. Packaging and shipping procedures must be in accordance with prevailing regulations. There must also be suitable arrangements for acceptance and storage of materials on

the job site. Storage must provide for protection of materials from deterioration, as well as conformance to prevailing safety and environmental regulations. Spill kits must be present and procedures established to clean up spills, and any hazardous waste generated must be stored and disposed of in accordance with local regulations.

8.3.1.7 Site Conditions. The site conditions must be completely and correctly defined. Variations from the description of the site conditions generally cause costly changes in the specification. They may concern the size or scope of the work, the extent of corrosion or coating deterioration, the construction or coating materials, or other things that affect the work to be done. Some specification writers do not examine the job site but rely on drawings on file that may not be current. Additions significantly increasing the level of effort may have occurred since the drawing was made. The Federal Government does not require inspection of the job site before bidding, because it might be unduly costly to bidders located in other geographical areas. Thus, bidding may not be as precise as if the site were inspected. In fact, some bidders deliberately do not inspect the work site in hope of finding variations that would bring additional money to them.

Another common error is to underestimate the amount of loose, deteriorated coating that must be removed in maintenance painting. Loose paint is generally not well defined. The best definition is probably paint that can be removed with a dull putty knife.

Recently, a number of contracts have been awarded that involve the removal of paint containing lead, chromium, asbestos, or some other toxic material. Such paints must be identified as containing hazardous material before the contract is advertised.

8.3.2 Products Part. The products part of a specification includes requirements for materials to be used. This may include abrasives and other cleaning materials and thinners, as well as coating materials. Historically, materials with proven performance and low life-cycle costs were usually chosen. Now, most heavily populated areas require lead- and chromate-free coatings that are low in VOCs. These are frequently more difficult to apply than earlier formulations, have had very little field testing, and thus may provide shorter term protection.

Paint products are always best procured using a specification or a specific brand name, if this is permitted and if the product has data showing good field performance. Many

Government agencies cannot purchase a sole source product, unless it can be shown to be uniquely differentiated from other products. Sometimes, a qualified products list can be used or suggested suppliers of coatings for a particular specification, for which good performance data are available. Specifying "Brand X or equal" is dangerous, because there is no specific definition of "equal" or procedure to determine such equality. Also dangerous is to describe a product by its composition and/or performance. These are sometimes done to procure a particular product without calling out its name. Standard colors available in the particular specification or commercial product should be specified. FED-STD-595 provides a large number of color chips for which many specification coatings are available. A fandeck of these chips is also available from the General Services Administration (GSA). It is better to use these standards than to refer to a particular supplier's color code or name.

Whatever the method of specifying products, it is always best to require that products for a multiple-coat system be procured from the same supplier, who recommends their use together. This will avoid compatibility problems and limit any liability to one supplier.

8.3.3 Execution Part. The execution part of the specification describes the use of the materials in the products part. Because painting may be only a small part of a construction project, it must be coordinated with the other sections. This will permit surface preparation and coating application under suitable conditions and without delays or other interference.

Much information of the execution of a specification may be found in drawings that form a part of the specification. To prevent problems resulting from variations between descriptions in the drawings and the body of the specification, requirements in the body should be stated as preempting those in drawings. They should not repeat requirements in the body of the contract to avoid differences.

8.3.3.1 Work Conditions. This portion of the execution part describes the weather conditions under which work is permitted. If priming of steel is delayed by the weather or other reason, it will be necessary to reblast the steel to remove any flash rusting that has occurred during the delay.

The air temperature at the time of coating application should be in the supplier's listed acceptable range. The temperature should be at least 5 degrees above the dew point, and

rising, to prevent moisture from condensing on the surface of the wet paint film. The specification should state how frequently temperature and dew point measurements should be taken.

Spray painting should also be restricted during times of moderate to heavy winds. Painting at such times may not only produce unsatisfactory films of coating but also result in overspray onto automobiles or other structures in the area.

8.3.3.2 Surface Preparation. It is always best to describe the desired prepared surface condition, using standards such as SSPC SP 6, if available, rather than telling the contractor how to prepare the surface. It is inappropriate to specify both the desired condition and how to achieve it. These requirements may cause legal problems if the surface cannot be obtained using the directions specified. For example, it is much more effective to require a "SSPC SP 10, Near-White Blast Cleaning" without specifying how the blaster achieves it. However, if the specification calls for abrasive blasting of steel at 90 to 100 psi using a venturi nozzle held 8 inches from the surface, then there can be no requirement for a particular degree of cleanliness other than that which is achieved when the specific directions are followed.

Care must also be taken to use only standard terms such as "brush-off blast cleaning" which is defined in SSPC SP 7 rather than "brush blast," "sweep blast," "shower blast," or some other undefined term. Also avoid other vague terms such as "heavy abrasive blasting" that are subject to interpretation.

8.3.3.3 Coating Application. Normally, painters are permitted to apply their materials by brush, roller, or spray, unless the material can only be applied satisfactorily by one or two of these methods. Thus, zinc-rich coatings should be applied by spray using an agitated pot and following the instructions of the coating supplier. SSPC PA 1 may be referenced as an industrial standard for shop and field painting. Local transfer efficiency requirements may prevent the use of some types of spray application (e.g., airless or conventional air spray). Currently, requirements for transfer-efficient methods of application are limited to shop work. Any thinning of paints should be limited to thinner and the amount recommended by the supplier. It should also be within the limits set by local air pollution authorities.

8.3.3.4 Inspection. In the inspection section, inspection requirements should be listed. By referring to standard test procedures, details of both the procedures and their requirements

can be found. Thus, SSPC PA 2, Measurement of Dry Paint Thicknesses With Magnetic Gages, will indicate how many thickness measurements must be made on each 100 square feet of coated steel surface. If referencing SSPC PA 2, then do not reference ASTM D 1186, Nondestructive Measurement of Dry Film Thickness of Nonmagnetic Coatings Applied to a Ferrous Base. Slight differences in these standards can cause problems.

Occasionally, the contractor and the representative of the contracting officer informally agree on a surface preparation standard for inspection. Often, this is a protected area of steel, or a reference panel, that has been blast cleaned to an acceptable level. Such agreements should be put down in writing and signed by both parties. It then becomes an amendment to the specification and can resolve any disputes that may arise concerning the agreement.

8.4 Language to be Used in Specification. In order to meet the goal of preparing a correct, clear, and concise specification, the language of the document must be such as to describe exactly what is desired. The contractor is required to provide the product described in the specification, not necessarily what is desired. In order to do this, the specification writer must be very precise with his language. The following recommendations will help:

- a) Use short, specific words (avoid vague terms)
- b) Use short sentences
- c) Put the action words up front
- d) Use strong verbs
- e) Use the imperative mood
- f) Do not repeat descriptions or requirements

8.4.1 Concise Words. Words in the specification should be relatively short, specific, and readily understood. Avoid words that are ambiguous, vague, or otherwise not readily understood. Such expressions as "high-performance coatings" and "quality workmanship" are too vague to be used.

a) Short sentences are more readily understood than longer ones. Also, the action words (subject and verb) should go up front. Thus, don't write, "After the steel has been properly

cleaned and after the weather conditions have been verified to be acceptable, apply one coat of the specified primer." Instead, write, "Apply one coat of the specified primer after . . ."

b) Strong verbs such as "blast," "clean," and "prime" are more precise than weaker verbs such as "make," "build," and "establish." They are also more easily understood. Use of the imperative mood is preferred, because it is more concise and more easily understood. Thus, "Blast clean to an SSPC SP 10 surface" is better than, "The surface shall be blast cleaned to an SSPC SP 10," or, "The contractor shall clean the surface to an SSPC SP 10."

c) No information in the specification should be repeated in a second place because of the greater possibility of errors or because slight differences in description may receive different interpretations.

8.5 Construction Criteria Base. The Construction Criteria Base (CCB) is a compact disc system containing the complete texts of thousands of documents needed for the design and construction of buildings and civil works, together with built-in software for automatic accessing and processing the information. The CCB can be obtained from the National Institute of Building Sciences, 1201 L Street, N.W., Washington, DC 20005.

Section 9: INSPECTION OF PAINTING OPERATIONS

9.1 Scope of Section. This section describes the duties of an inspector, general inspection procedures, and specific inspection methods used in inspecting painting operations. Depending upon the job and the contract requirements, quality-control inspectors may be contractor-supplied (that is, contractor quality control - CQC) or Government personnel. In either case, the contracting officer is responsible for ensuring the quality of the job. The intent of this section is to describe proper inspection procedures so that Government personnel will know either how to inspect a painting operation or to ensure that someone else has done it correctly.

9.2 Importance of Inspection. The success of a painting job depends upon the specification requirements being met for surface preparation, application and materials. Most coating failures are the result of contract requirements not being met. Inspection procedures are designed to detect situations when the requirements of the contract are not being met. Thus, inspection is a key factor in obtaining the performance and durability built into the specification.

9.3 Contractor Quality Control Inspection. In Government painting, quality control inspection is often provided by the contractor. For large jobs, a contractor usually hires an inspector. For smaller jobs (less than \$200,000), a contractor's superintendent may carry out the quality control inspection. If deemed necessary because of the size or difficulty of a job, or because of the crucial function of a structure, the contract specification can require the contractor to hire a certified inspector (e.g., NACE has a certification program). In this way, the contractor's inspector may be more independent of the contractor and may have better inspection skills. Although this requirement may increase inspection costs, the increased cost of proper inspection as opposed to none or poor inspection has been found by the private sector to be cost effective. Quality control inspectors should report deviances from the contract specification in writing to the contracting officer. Appropriate governmental action in response to these reports is essential in obtaining the quality of the job built into the specification.

9.4 Duties of an Inspector. The duties of an inspector include understanding the contract specification requirements, making sure that the specification requirements are met by the contractor, and keeping good records. Record keeping is a very important part of inspection. It should occur during all phases of the job. Records form an important part of the permanent record on each building, and provide key information in the case of contract disputes.

9.4.1 Record Keeping. Inspectors should keep records in a bound book (logbook). Each page should be initialed by the inspector and dated. The record book should contain:

a) Written records of verbal agreements made between the contracting officer or the inspector and the contractor.

b) Daily descriptions of the type of equipment and number of workers on the job site.

c) Descriptions of the coating materials that are on site.

d) Records of the rate of work progression.

e) Measurements of ambient conditions.

f) Results and observations of the surface preparation inspection.

g) Measurements and observations of coating application, including time between surface preparation and coating application, and times between coats.

h) Results of the final and warranty acceptance inspections.

It is especially important that agreements between the contracting officer (or designee) and the contractor that modify the contract specification be in writing and be signed to minimize future disputes.

9.5 Inspection Equipment. A description of equipment used in typical inspections is summarized in Table 15. Instructions on its use are provided in Section 10 and in the equipment manufacturer's literature. Some of the equipment is readily available from local hardware or variety stores but some is specialized equipment for painting operations. Suppliers of specialized equipment are listed in:

a) ASTM, 1916 Race Street, Philadelphia, PA 19103.

b) NACE, P.O. Box 218340, Houston, TX 77218.

c) SSPC, 516 Henry Street, Suit 301, Pittsburgh, PA 15213-3738.

d) Paul N. Gardner Company, Inc., Gardner Building, P.O. Box 10688, Pompano Beach, FL 33060-6688.

e) KTA-TATOR, Inc., 115 Technology Drive, Pittsburgh, PA 15275.

f) ZORELCO, P.O. Box 25500, Cleveland, OH 44125.

g) Pacific Scientific, 2431 Linden Lane, Silver Spring, MD 20910.

h) S. G. Pinney & Associates, 2500 S.E. Midport Road, P.O. Box 9220, Port St. Luice, FL 34952.

9.6 Inspection Steps. The inspector's tasks can be divided into eight general steps, which are summarized in Table 16 and discussed in more detail below. Special equipment required in each of these steps is also listed in the table. A form that may be useful in reviewing the contract is provided in Figure 21, and one for organizing inspection data is provided in Figure 22.

9.6.1 Review Specification and Correct Deficiencies, If Any. The first part of any inspector's job is to read and understand the contract specification. If deficiencies are found, resolution of the deficiencies between the contracting officer and the contractor is needed prior to start of work. Any changes in the contract specification must be documented in writing and signed by the two parties or their representatives. Copies of these agreements should be kept in the inspector's records. In addition to reviewing the specification, the inspector must also review the contract submittal. The form shown in Figure 21 may help an inspector to identify key specification requirements and essential information from the submittals, and to prepare for the preconstruction conference. Note that at this time, all the information needed to complete the form may not be available. However, the information should be available before the start of the job.

9.6.2 Visit Job Site. It is important for the contractor to visit the job site with an inspector prior to the preconstruction conference so that the scope of the job and any constraints are understood. Potential problems that are found, such as difficulty with access to the job site, can then be resolved at the preconstruction conference. Such visits have been shown to be effective in reducing problems during the job.

Table 15
Equipment for Inspecting Painting Operations

Tool	Typical Use	Description	Source
SSPC VIS 1 and VIS 3 visual standards	Surface preparation of steel	Colored prints illustrating the degrees of blast, hand or power-tool cleaning	SSPC
NACE TM0170 and TM0175 standards	Surface Preparation of steel	Abrasive blasted steel panels illustrating 4 degrees of cleaning	NACE
ASTM standards	Surface preparation, application, and approval	Test methods for measuring profile, film thickness and comparing quality	ASTM
Comparator gage	Determine surface profile of blast cleaned steel	Field instrument consisting of comparator discs and lighted magnifying glass	Supplier
Replica tape	Determine surface profile of blast cleaned steel	Plastic backed foam-like material used to make a reverse image of blasted surface	Supplier
Micrometer	Surface preparation, dry film thickness	Instrument with adjustable opening to measure small thicknesses	Supplier
Inspection mirror	Surface preparation, application	Instrument with mirror on end of handle	Supplier
Moisture meter	Application	Instrument to measure moisture content of substrate	Supplier
Camera	Throughout job		
Sling psychrometer/ psychrometric tables	Ambient conditions	Instrument consisting of wet and dry-bulb thermometers used with a table to determine relative humidity and dew point	U.S. Government Printing Office
Surface thermometer	Application	Special thermometer to measure temperature of substrate	Supplier
Clean cloth or blotter	Application	Use to detect oil in compressed air lines	Supplier
Wet film thickness gage	Application, approval	Flat metal panel with notches of various depths corresponding to expected thicknesses	Supplier
Dry film thickness gage	Application, approval	Magnetic or other gages to measure dry film thickness	Supplier
Magnifying lens	Application, approval	Illuminated microscope, 5x and higher	Supplier
Holiday detector	Application, approval	Portable, low voltage noise detector for detecting coating flaws or discontinuities on metal substrates	Supplier
Adhesion testers	Application, approval	Field instruments to measure either tensile or peel adhesion	Supplier

Table 16
Inspection Steps

Action	Brief Description	Tools (Not all may be needed for any particular job)
Review contract specification and submittals	Determine specified coating, surface preparation, application procedure and final appearance	Contract specification, material technical data sheets, Figure 21
Visit job site	Ensure that the contractor understands the scope and difficulties of the job	
Conduct preconstruction conference	Discuss painting job with contractor	Contract specification, visual standards, material technical data sheets
Carry out presurface preparation inspection	Ensure that repairs are complete, oil, grease, weld splatter are removed, surrounding area is protected from potential damage	
Inspect coating material	Ensure adequate material is on the job site; examine age and condition of coatings and storage facilities	Paddle for stirring
Assess ambient conditions	Throughout the painting job, measure air and surface temperature, relative humidity and dew point, and wind velocity	Psychrometer and chart, surface thermometer, and weather data
Inspect surface preparation	As required, inspect surfaces for cleanliness, profile, removal of loose paint, chalk, mildew, soil and grease	Comparator, surface preparation standards (SSPC VIS 1 and VIS 3, NACE TM-01), felt for chalk measurement, visual standards for chalk and mildew assessment, instrument for measuring profile
Inspect coating application	Ensure specified materials are used; check thinner and amount of thinning; measure dry film thickness and determine that one layer has dried/cured properly before another is applied	Material technical data sheets, wet and dry film thickness gages
Final approval of complete system	Examine film for thickness, appearance, uniformity, and defects	Camera, dry film thickness gage, holiday detector (if needed), magnifying glass, adhesion tester

Project No. _____ Project Title _____ Inspector _____ Contractor _____

Buildings in Contract, Nos. _____

Coating Materials

Primer: Manufacturer _____ Product Designation _____ Color _____

Batch _____ Volume Solids _____% Number of Components _____ Storage Temp. _____

Recommended Thinner _____ Maximum Thinning Recommended _____

For multi-component paints: Mixing Ratio _____ Induction Time _____ Pot Life _____

Midcoat: Manufacturer _____ Product Designation _____ Color _____

Batch _____ Volume Solids _____% Number of Components _____ Storage Temp. _____

Recommended Thinner _____ Maximum Thinning Recommended _____

For multi-component paints: Mixing Ratio _____ Induction Time _____ Pot Life _____

Topcoat: Manufacturer _____ Product Designation _____ Color _____

Batch _____ Volume Solids _____% Number of Components _____ Storage Temp. _____

Recommended Thinner _____ Maximum Thinning Recommended _____

For multi-component paints: Mixing Ratio _____ Induction Time _____ Pot Life _____

Surface Preparation:

Method _____ Standard for Cleanliness _____ Profile: min _____ max _____

Special Instructions _____

Application:

Ambient Conditions Limitations: Minimum Temperature _____ Maximum Temperature _____

Minimum % Relative Humidity _____ Maximum % Relative Humidity _____

Minimum Difference Between Dew Point and Surface Temperature _____

Equipment Requirements _____

Special Instructions _____

Date _____ Project No. _____ Project Title _____ Inspector _____										
Time	Location	Wet Bulb	Dry Bulb	Rel. Hum.	Dew Point	Surface Weather			Material Temp.	
						Temp	Condition	Wind Vel.	At Applic.	Storage

Painting Operation Report

Bldg No.	Location	Operation (# people on site, activity type)	Surface Preparation			Mois-ture Content	Color		Application			Dry Film		
			Type	Clean-ness Level	Pro-file		Spec No.	Color No.	Method	Wet Film Thick	Cure Time	Spec Thick	Ac-tual Thick	Meas. Meth-od

Figure 22
Sample Daily Project Reports for Painting Inspectors
145

9.6.3 Conduct Pre-Construction Conference. At the beginning of each new contract or work order before the start of any surface preparation or coating application, a meeting should be held with the contractor, contracting officer, inspector, and other key people. Figure 21 may be helpful in this discussion. During this conference, agreement should be reached on details of the specification and the procedures and expectations of the inspector. For example, the number and locations for inspecting surface preparation and coating thickness should be determined. Scheduling, job sequencing, job stops for inspection, and other job-related issues should be discussed. Differences between contractor and contracting officer should be resolved at this time to avoid future misunderstandings and job delays. Agreements that result in a change of the contract should be made in writing, signed and included in the record book.

9.6.4 Inspect Job Site After Pre-Surface Preparation. Prior to surface preparation or coating application, it is necessary to be certain that requirements in the specification relating to readying a surface or area for painting are carried out. These may include protecting adjoining surfaces, removing weld splatter, ensuring that surfaces are free of oil and grease, grinding sharp metal edges, protecting plants and other shrubbery, replacing rotted wood, caulking joints, and the like.

9.6.5 Inspect Coating Materials. Coating materials must be inspected at the job site to identify deficiencies that could result in failure of the paint film. The following checklist can be used:

a) Read labels on the coatings to verify that the coatings are the ones specified or approved.

b) Take one representative 1-quart sample in accordance with the specification. Retain the sample for a period of 1 year from the date of final approval of the contract work in case of coating film failures or contract disputes.

c) Ensure that coating materials are in sealed, unbroken containers that plainly show that the date of manufacture is within 1 year. The label should display the manufacturer's name, specification number/or designated name, batch number, and FED-STD-595 color.

d) Inspect the paint after stirring for homogeneity, weight, viscosity, color, and smell. If deficiencies are suspected from these tests, the paint should be sent to a laboratory for testing. A kit developed by the Army Construction

Engineering Research Laboratory (Champaign, IL 61802, 1-800-USA-CERL) is available that will assist the inspector in field inspection of latex and oil-based paints.

e) Count the cans of paint on the job site to determine that a sufficient quantity is available to complete the job as specified. For multi-component paints, confirm that the proper ratio of materials for each specific coating is present. To estimate the paint required for a job, use the nomograph reproduced from a Naval Facilities Engineering Service Center (Port Hueneme, CA 93043) Techdata Sheet shown in Figure 23.

f) Ensure that the paint is stored on site in an approved building or area.

g) Record number of cans and paint condition in record book.

9.6.6 Measure Ambient Conditions. Most coating systems will not dry or cure properly under extremes of temperature or humidity, nor will they adhere well if applied over damp surfaces. For example, specifications often require that the substrate surface temperature be 5 degrees F above the dew point and rising. For these reasons painting contracts have requirements for air and surface temperature, dew point, and, perhaps, additional environmental conditions. The paint manufacturer's technical data sheet will also have limits for acceptable environmental conditions. (If the limits are in conflict, agreement on the limits should be reached during the preconstruction conference.) Because temperature and dew point may vary considerably within a small area, temperature and dew point should be measured in the immediate vicinity of the work being done. Surfaces being painted may be colder than the atmospheric temperature and their temperatures should be measured in addition to atmospheric temperatures. Dew point at the surface being painted may also be different from that in the air away from the surface. Thus, dew point should be measured near the surface. Ambient condition measurements should be made about every 4 hours. These times should include before start of job, after breaks, and after sudden changes in environmental conditions. Sudden changes in environmental conditions should also be recorded in the logbook. In addition, do not paint in rain, snow, fog, or mist, or when the surface is covered with frost.

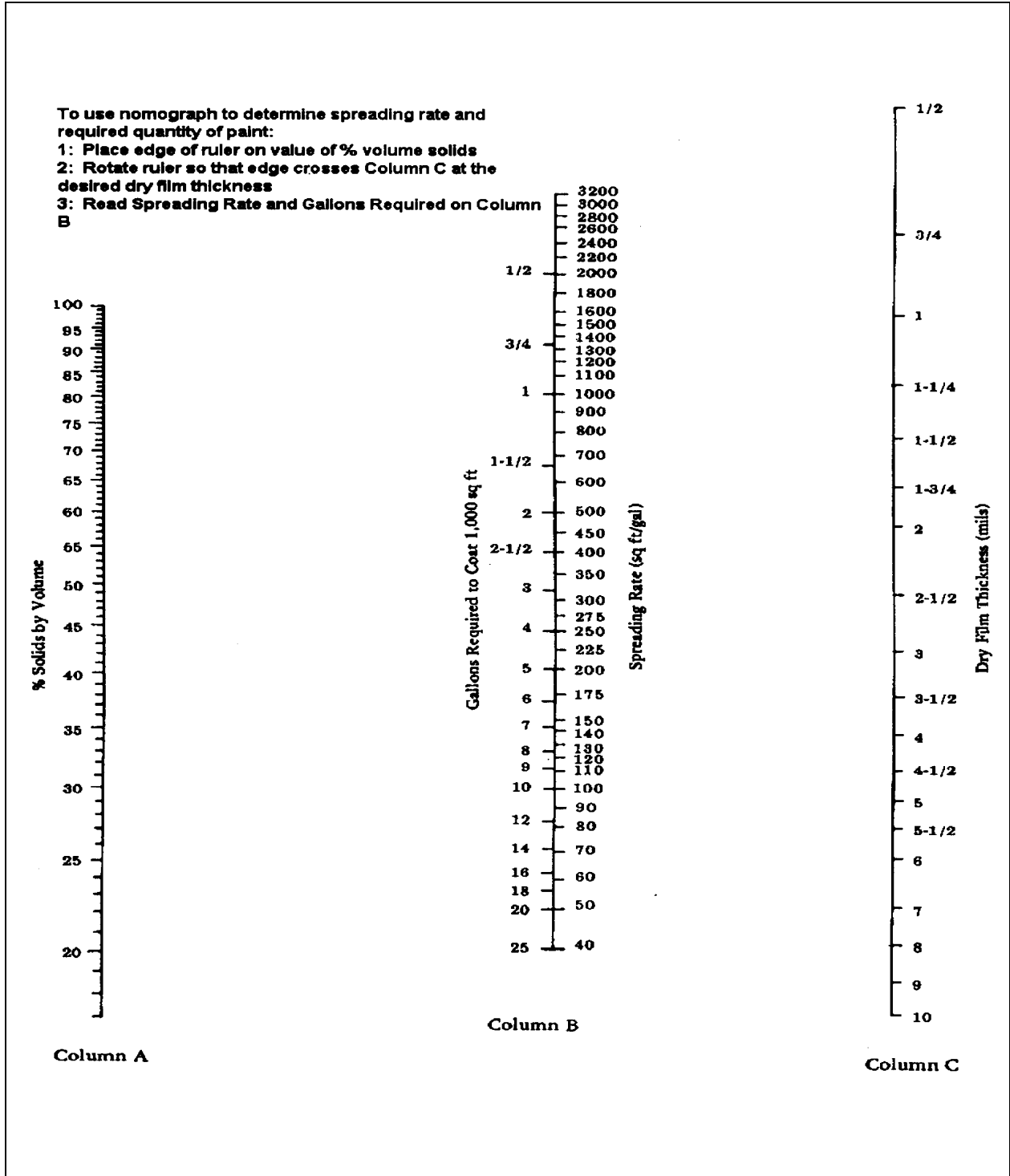

Figure 23
 Nomograph for Estimating Quantities of Paint Required for a Job

9.6.6.1 Relative Humidity and Dew Point. These conditions are measured using a psychrometer. Most psychrometers consist of a wet bulb thermometer, a dry bulb thermometer, and a standard psychrometric table. Using the table, the relative humidity is obtained from the two temperature readings. More detailed information is provided in Section 10.

9.6.6.2 Surface Temperature. Surface temperature is measured using a special thermometer in which the temperature sensing element is designed to come into intimate contact with the surface and to be shielded from the surrounding air. The surface temperature of the coldest and warmest surfaces should be within the limits of the specification. The location, temperature and time of the measurement should be recorded in the record book.

9.6.7 Inspect Surface Preparation. Surface preparation inspection procedures include inspecting equipment, and associated materials (e.g., blasting medium and chemicals), as well as the cleaned surface itself. Proper surface preparation, as described in the specification, must be completed to obtain a durable coating film. Additional information on surface preparation is presented in Section 6. Many of the surface preparation requirements involve visual inspection of the surface, and some are subjective. For example, the specification may require removal of loose paint (for example, paint that can be removed by a dull putty knife), removal of surface chalk to some specified level and feathering of edges on the remaining paint film. To help avoid conflicts between the contractor and the inspector, it may be useful to have the contractor prepare a test surface about 4 by 4 feet that can then be used as a standard for surface preparation. Photographs of the test surface could be part of the inspection record. For steel, the test surface should be protected by a clear coating.

When blast cleaning is part of the surface preparation, it should be performed in a manner so that no damage is done to partially or entirely completed portions of the work, adjacent surfaces, or equipment. Usually blast cleaning should progress from the top towards the bottom of a structure, should be carried on downwind from any recently painted structures, and should not scatter abrasive on or into surrounding buildings or equipment. All dust from blasting operations must be removed by brushing, blowing, or vacuuming before painting.

9.6.7.1 Abrasive-Blasting Surface Preparation Equipment and Supplies

a) Air Cleanliness. Routinely (at least two times a day or every 4 hours) inspect air supply lines for both blast

cleaning or paint spray application to ensure that the air supply is clean and dry. A blotter test as described in ASTM D 4285 can be used to determine whether the air supply is free of oil and moisture. In this test, a clean white blotter is held downstream about 19 inches from the nozzle for 2 minutes. It should remain clean and dry.

b) Abrasive. Each batch or shipment of abrasive should be checked for oil contamination and, if required, soluble salts. Either can contaminate a cleaned surface and reduce the service life of the coating. A commonly used test to check for oil contamination is to take a small random sample of the abrasive, place it together with clean water in a small bottle or vial, shake the bottle for a minute and examine the surface of the water. There should be no sheen of oil on the surface of the water. Soluble ionic contaminants can be detected using the electrical conductivity test described in ASTM D 4940. In addition, the abrasive should feel dry to the touch when it is placed in the abrasive blasting machine. Recycled abrasives break down after several cycles, and the number of cycles depend upon the type of the abrasive. The abrasive should be replaced when it no longer meets the requirements of the specification.

c) Blast Hoses and Nozzles. Blast hoses should be in good condition and kept as short as possible. The nozzle pressure and diameter of the nozzle orifice both affect the cleaning rate. A nozzle orifice gage is used to determine the orifice size. Air pressure at the nozzle is measured using a hypodermic needle air pressure gage and should be from 90 to 100 psi for optimum efficiency. Usually these parameters are measured at the start of a job and when production rates are decreasing. An increase of nozzle size of more than 1/8-inch causes loss of cleaning efficiency because of the increased pressure drop. Increased nozzle size also causes increased use of abrasive. Profile should be inspected when major changes in cleaning efficiency are noted.

d) Safety. Special safety precautions are required during abrasive blasting. Refer to Section 13 for more information. These precautions include use of external couplings on blast hoses and dead man controls, and electrical grounding of equipment.

9.6.7.2 Water Blasting. Since contaminants, such as salts and oils, in the blasting water will be left behind on the blast-cleaned surface and may adversely affect the adhesion of the coating to be applied, water should be essentially free of contaminants. If cleaning agents are added to the water used for blasting and cleaning, the surfaces must be thoroughly rinsed with clear water. An exception is the use of flash-rusting

control agents when cleaning steel. These agents should only be used in accordance with the contract specification and the coating manufacturer's recommendations. As for abrasive blasting, hoses should be in good condition and kept as short as possible. Special safety precautions, similar to those used in abrasive-blast cleaning, also need to be taken. In addition, consideration should be given to the slipperiness of wet surfaces. More information on safety is provided in Section 13.

9.6.7.3 Frequency of Inspecting Cleaned Surfaces. The objective of the inspection is to ensure that the entire surface was prepared in accordance with the specification. The inspection report should provide a representative description of the cleaned surface. The specific number and location of places at which surfaces should be inspected must be in accordance with the contract specification. If not detailed in the specification, SSPC PA 2 can be used as a guide. Additional inspection sites that should be considered include those where the existing paint was failing, in hard-to-reach areas where surface preparation is difficult, and where major changes in equipment were made.

9.6.7.4 Inspecting Prepared Steel Surfaces

a) Cleanliness. If a small representative sample of surface was not prepared to use as the standard for surface preparation, the degree of blast or tool cleaning should be compared to the description given in the SSPC or NACE specification referred to in the contract specification. The appearance should correspond with the specified pictorial standards of SSPC VIS 1, SSPC VIS 3, or a NACE panel. Complete descriptions of the degrees of cleanliness are found in Section 6. After blasting, blast-cleaned surfaces must be cleaned (e.g., vacuum, air blast, or brushing) to remove traces of blast products from the surface or pitted areas. One of two tests for cleanliness can be used. In one, a white glove or other clean cloth is rubbed over the surface and examined for soiling or debris, and in the other, a piece of clear adhesive tape is applied to the surface, removed and the adhesive side examined for debris.

b) Profile. Profile is measured using one of three pieces of equipment: comparator, depth micrometer, or replica tape. It should be noted that the three techniques may give slightly different results. Complete descriptions of standard methods for each of these techniques are described in ASTM D 4417, Field Measurement of Surface Profile of Blast Cleaned Steel and in Section 10.

9.6.7.5 Inspecting Concrete, Masonry, Wood, Plaster, Wallboard, Old Paint. On these surfaces, specifications may have requirements for measurements of moisture content and residual chalk, as well as visual condition. The specification should state how moisture is to be measured, since the different methods provide different types of data. Moisture content can be measured either using a plastic sheet test (ASTM D 4263) or an electric moisture meter. In the plastic sheet test, a piece of plastic film is taped (all edges) to the surface. After 24 hours, the film is removed and the underside is examined for the presence of condensed water. Prior to application of most coatings, the sheet should be free of condensed water. This is because accumulation of water at the concrete/primer interface will usually lead to delamination of the primer. To use a moisture meter on hard surfaces, small holes must be drilled for the electrodes. These holes should be repaired after the measurements are completed. The contract should state a moisture requirement. Residual chalk is usually measured using a piece of cloth of contrasting color, in accordance with ASTM D 4214. Other procedures are also described in ASTM D 4214. In the cloth method, a piece of cloth is wrapped around the index finger, placed against the surface and then rotated 180 degrees. The spot of chalk on the fabric is compared with a photographic reference standard. Chalk readings of 8 or more indicate adequate chalk removal providing reasonable assurance that the new coating should not fail because of application to a chalky surface.

9.6.8 Inspect Coating Application. Proper application is another essential factor in determining paint performance, and the requirements of the specification must be followed. General guidance on paint application is presented in Section 7 and SSPC PA-1. Inspectors should assess ambient conditions, application equipment, ventilation, mixing, film thickness, and drying and curing conditions to ensure that they are within the limits of the specification and the technical data sheets for the paints. It is especially important that the paints be applied and cure within the temperature and relative humidity limits of the specification, since these conditions affect film formation. A properly dried and cured film is essential for satisfactory paint performance, and deviations from these limits may prevent proper film formation. For two-component systems, the inspector should ensure that the materials were mixed together and in the proper ratio. For all materials, thinning should only be allowed in accordance with the manufacturer's data sheet.

9.6.8.1 Application Equipment. Equipment to apply the coating must be in acceptable working condition. When spraying, the spray pattern should be oval and uniform, the gun should be held at the proper angle and distance from the surface, and each spray

pass should overlap the previous one by 50 percent. Proper techniques should also be used for brushing, rolling, or other application procedures. Refer to Section 6. Special safety requirements for paint application are described in Section 13.

9.6.8.2 Ventilation. The ventilation of tanks and other enclosed areas where paint is to be applied and cured must meet the requirements of OSHA's Confined Space Regulation, and the contractor's safety plan required by contract specification. Good ventilation is also necessary for proper coating cure.

9.6.8.3 Mixing/Thinning. Paints must be properly mixed as described in Section 7. Paint solids often settle out during storage and must be completely blended into the paint vehicle, resulting in homogeneous mixture. For multi-component paints, the inspector should ensure that all components have been mixed in the proper proportion, that the mixing is thorough and that the resulting paint is uniform in appearance. Required induction times must also be met to obtain satisfactory application and film properties. Although the paint manufacturer prepares paint to produce a consistency for brushing, rolling, or spraying, sometimes additional thinning is permitted in the specification. Thinning of the paint must follow manufacturer's instructions for both type and amount of solvent. A thinned paint will cover more surface area but the dry film thickness will be less and may not meet the requirements of the specification.

9.6.8.4 Film Thickness. Contract specifications may require a minimum and/or a maximum dry film thickness for each coating application. Wet film thickness measurements made at the time of paint application are used to estimate dry film thickness so that appropriate adjustments in the application procedure can be made to meet the specification. Wet film thicknesses are not used in meeting contract requirements because of the many factors (solvent evaporation, wetting energies) that affect the measurement. Procedures for making wet film thickness are described in ASTM D 4414, Wet Film Thickness by Notch Gages and in Section 10. The dry film thickness is estimated from the wet film thickness according to:

$$\text{Dry Film Thickness} = \frac{\text{Wet Film Thickness} \times \text{Percent Volume Solids}}{100}$$

The percent volume solids is available from the coating manufacturer's data and should be part of the inspector's records. Dry film measurements are made after the coating has hardened. For steel surfaces, thickness measurements can be made according to SSPC PA 2 or ASTM D 1186 or ASTM D 1400, Nondestructive Measurement of Dry Film Thickness of Nonconductive Coatings Applied to a Nonferrous Metal Base. (There are some

differences in calibration procedures between SSPC PA 2 and the ASTM standards. If the contract specification does not specify the exact procedures to be used, the procedures should be agreed upon, and the agreement documented, during the preconstruction conference.) ASTM D 4128, Identification of Organic Compounds in Water by Combined Gas Chromatography and Electron Impact Mass Spectrometry describes a destructive procedure for measuring coating thickness on non-metallic substrates using a Tooke gage (refer to Section 10). If the contract specification requires minimum film thicknesses for each layer, the measurements must be made after each layer has cured, taking care not to depress soft coatings during measurements.

9.6.8.5 Drying. The inspector should ensure that a previous coat has dried or cured as required by the contract specification before another coat is applied. For most thermosetting coatings, manufacturers specify a maximum, as well as a minimum, curing time before application of the next coat. In some situations, a coating manufacturer may require use of a methyl ethyl ketone (MEK) rub test to assess curing prior to application of another layer. The inspector's record should provide information so that the dry/cure time for each layer can be determined.

9.6.9 Final Approval Procedures. The final approval inspection is very important since it determines whether the contract requirements have been met, and whether identified deficiencies have been corrected. Since most coatings function as a barrier and since the protection of a surface is usually directly related to coating thickness and continuity, inspection of coating thickness and film continuity are essential. The following checklist can be used to inspect the final job:

a) Examine, as required by the specification, the cured coating system for visual defects, such as runs, sags, blistering, orange peel, spray contaminants, mechanical damage, color and gloss uniformity, and incomplete coverage. Note any areas of rusting, or other evidence of premature failure of the coating system.

b) If defects are observed, bring them to the attention of the contractor for correction. If resolution of the corrective action cannot be reached with the contractor, bring the matter to the attention of the contracting officer. Dated photographs of the defects could become part of the inspector's records, if deemed appropriate.

c) Measure and record the total dry film thickness using appropriate gages. When the Tooke gage is used, the coating must later be repaired.

d) Measure adhesion as required in the contract specification. Adhesion measurements vary from those made with a knife (ASTM D 3359, Measuring Adhesion by Tape) to those that determine the amount of force needed to remove a dolly (Section 10 and ASTM D 4541, Pull-Off Strength of Coatings Using Portable Adhesion Testers) that has been cemented to the surface.

e) Examine the coatings on steel structures for pinholes using a holiday detector as described in NACE RP0188 and Section 10, if required in the contract specification.

f) Record the results of observations in the record book. Document photographs taken and retain in the record book.

9.6.10 Year Warranty Inspection. The warranty inspection includes a visual inspection of the film, and may involve a chalk, film thickness, and adhesion measurements. Since the film was found to be essentially free of defects upon completion of the job, a goal of the inspection is to identify contractually unacceptable defects that have formed during the course of the year. Resolution of film deficiencies should follow the same steps as for the final inspection. Deficiencies should be recorded in the logbook. Documented photographs (date, location, and photographer) should be included if deemed necessary to resolve contract disputes.

Section 10: FIELD INSPECTION INSTRUMENTS

10.1 Introduction. This section describes field instruments commonly used in inspection of field painting. The References section of this handbook lists the full title and sources of standard test methods referenced in this section. For equipment descriptions having no referenced standards, no standards are available. Typical suppliers include:

a) Paul N. Gardner Company, Inc., Gardner Building, P.O. Box 10688, Pompano Beach, FL 33060-6688.

b) KTA-TATOR, Inc., 115 Technology Drive, Pittsburgh, PA 15275.

c) ZORELCO, P.O. Box 25500, Cleveland, OH 44125.

d) Pacific Scientific, 2431 Linden Lane, Silver Spring, MD 20910.

e) S. G. Pinney & Associates, 2500 S.E. Midport Road, P.O. Box 9220, Port St. Luice, FL 34952.

10.2 Illuminated Microscope. A pocket-sized illuminated microscope is frequently used to detect mill scale, other surface contamination, pinholes, fine blisters, and other microscopic conditions during painting operations. These microscopes are available with magnifications of 5 and higher.

10.3 Instruments for Use With Abrasive Blasting. A few instruments are available for testing the operational readiness of equipment for abrasive blasting of metals for painting.

10.3.1 Gage for Determining Nozzle Pressure. A pocket-sized pressure gage with a hypodermic needle is used to determine the blasting pressure at the nozzle. The needle is inserted in the blasting hose just before the nozzle in the direction of the flow. Instant readings can be made up to 160 pounds per square inch (gage) (psig).

10.3.2 Wedge for Determining Diameter of Nozzle Orifice. A hand-held calibrated wedge is inserted in the direction of flow into the nozzle orifice to determine its size (inches) and airflow (cfm at 100 psig). The orifice measuring range is 1/4 to 5/8 inch, and the airflow range is 81 to 548 cfm.

10.3.3 Surface Contamination Detection Kit. The level of cleanliness of abrasive blast cleaned steel can be determined by comparing it with SSPC VIS 1 photographic standards. SSPC VIS 3 photographic standards are used for determining level of

cleanliness of hand-cleaned steel and power-tool cleaned steel. Standard coupons of steel blasted to different levels of cleanliness are also available for comparison from NACE, and procedures for their use are given in NACE TM0170. Test kits for detection of chloride, sulfate, and ferrous ions, as well as pH, are commercially available. They contain strips, swabs, papers, and operating instructions for simple chemical testing.

10.3.4 Profile of Blasted Steel. There are three methods for determining the profile (maximum peak-to-valley height) of blasted steel surfaces described in ASTM D 4417.

10.3.4.1 Comparators. Several types of comparators are available for determining surface profile. These include ISO, Clemtex, and Keene-Tator comparators. Basically, they use a 5-power illuminated magnifier to permit visual comparison of the blast-cleaned surface to standard profile depths. Standards are available for sand, grit, and shot-blasted steel.

10.3.4.2 Surface Profile Gages. A surface profile gage is an easy instrument to use to determine surface profile, but 10 to 20 measurements must be averaged to obtain reliable results. The gage consists of an instrument with a flat base that rests on the profile peaks and a tip that projects into the valleys. The tip can be blunted by dragging it across steel surfaces. This prevents the tip from reaching the bottom of the valleys in the profile, resulting in a profile value that is less than the correct value.

10.3.4.3 Testex Press-O-Film Replicate Tape. Testex Press-O-Film replicate tape produces the most precise profile measurements, according to the precision statement of ASTM D 4417. The tape consists of a layer of deformable plastic bonded to a polyester backing. The tape is rubbed onto the blast-cleaned surface with a plastic swizzle stick to produce a reverse replicate of the profile. The tape profile is then measured with a spring micrometer. The micrometer can be set to automatically subtract the 2-mil non-deformable polyester backing. After measurements, the tapes can be stored as records of profile heights.

10.3.5 Thermometers. Several different types of thermometer and temperature recorders are available for field use. They are used to measure ambient temperatures, surface temperatures of steel, and temperatures of wet paints.

10.3.6 Psychrometers. Several different manual or battery-powered psychrometers are available for measuring air temperatures, relative humidity, and dew point. In most cases, two glass thermometers are used with the instrument, as described

in ASTM E 667, Clinical Thermometers (Maximum Self-Registering, Mercury-in-Glass). One thermometer has a clean "sock" or "wick" on it that is wetted with water. Air is circulated around the thermometers by the motorized fan or by whirling the hand-held sling psychrometer. Whirling should be with a steady, medium speed. Both thermometers should be read periodically and the airflow (whirling) continued until the reading becomes constant.

The "wet" bulb thermometer temperature will be lowered by evaporation of the water on the sock. The evaporation rate is related to the relative humidity and barometric pressure. Psychrometric tables relate temperature depression (difference between "dry" and "wet" bulb readings) to relative humidity and dew point. These standard tables, available from suppliers of psychrometers, cover the range from 23.0 to 30.0 inches barometric pressure. The effect of barometric pressure is relatively small; if it is unknown, use the 30.0-inch pressure table near sea level and the 29.0-inch pressure table at high elevations.

10.3.7 Wind Meter. A pocket-size wind meter is available for determining wind speed in miles per hour and velocity of air moving across a spray booth. Spraying on days with excessive winds can cause overspray or dry spray problems.

10.3.8 Moisture Meter. Meters are available for determining the moisture content of wood, plaster, concrete, or other materials. Some are nondestructive, while others require contact pins to be driven into the surface. An alternate non-destructive procedure for determining if too much moisture is present in cementitious surfaces is described in ASTM D 4263.

10.3.9 Wet Film Gage. Gages for determining paint wet film thickness are available in different types, two of which are described in ASTM D 1212 and one in ASTM D 4414. All are destructive in that they disturb the paint and require touching up the film.

10.3.9.1 Notched Metal Gage. The most widely used type of wet film thickness gage, described in ASTM D 4414, consists of a thin rigid metal notched gage, usually with four working faces. Each of the notches in each working face is cut progressively deeper in graduated steps. The gage with the scale that encompasses the specified thickness is selected for use. To conduct the measurement, the face is pressed firmly and squarely into the wet paint immediately after its application. The face is then carefully removed and examined visually. The wet film thickness is the highest scale reading of the notches with paint adhering to it. Measurements should be made in triplicate. Faces of gages should be kept clean by removing the wet paint immediately

after each measurement. An alternative circularly notched gage ("hot cake") is rolled perpendicularly through the wet film and the clearance of the deepest face wetted is noted.

10.3.9.2 Cylindrical Gage. A cylindrical wet film thickness gage is described in ASTM D 1212. These gages are also rolled through the paint rather than being pressed into it. They have an eccentric center wheel with constantly changing clearance supported by two outer wheels. The position on the exterior scale corresponding to the point that the wet paint first touches the eccentric wheel indicates the wet film thickness.

10.3.10 Dry Film Thickness Gages for Coatings on Aluminum, Copper, and Stainless Steel. Gages are available to determine the dry film thickness of organic coatings on aluminum, copper, and stainless steel. Alternating current from the instrument probe coil induces eddy currents in the metal that in turn induce magnetic fields that modify the electrical characteristics of the coil. ASTM D 1400 fully describes the instrument and its operating procedure.

10.3.11 Magnetic Dry Film Thickness Gages for Coatings on Steel. There are many different types of gages available for nondestructively determining the film thickness of cured organic coatings on metal surfaces. Most rely on the ferromagnetic properties of steel. Their use is described in detail in ASTM D 1186 and SSPC PA 2. They are available in different thickness ranges to provide the best accuracy with different coating thicknesses. Each has a probe or tip that is placed directly on the coating during measurement.

a) Magnetic thickness gages should be calibrated before use. It is also a good practice to check the calibration during and after use. Gage suppliers provide a set of standard thickness nonmagnetic (plastic or nonferrous metal) shims to cover their working ranges. The shim for instrument calibration should be selected to match the expected coating thickness. It is placed on a bare steel surface and the gage probe placed on it for calibration. If the instrument scale does not agree with the shim, it should be properly adjusted. If adjustment is difficult, the reading for bare steel can be added or subtracted from field readings to determine actual thicknesses.

b) The steel surface used for calibration should be a masked-off area of the steel being painted or an unpainted reference panel of similar steel, if possible. Pull-off gages are best calibrated using small chrome-plated steel panels of precise thickness (Standard Reference Material No. 1358, Certified Coating Thickness Calibration Standard) available from the National Institute of Standards and Technology (formerly the

National Bureau of Standards), Gaithersburg, MD 20899. These panels should not be used on magnetic flux gages, because the mass of steel is insufficient for their proper operation. Shims from pull-off gages should not be interchanged with those from magnetic flux gages.

c) About five field measurements should be made for every 100 square feet of painted surface. Each of these five measurements should be an average of three separate gage readings taken within an inch or two of each other. Measurements should be made at least 1 inch away from edges and corners.

10.3.11.1 Pull-Off Gages. Pull-off gages measure film thickness by stretching a calibrated spring to determine the force required to pull an attached permanent magnet from a coated steel surface. The simplest type of pull-off instrument is the pencil gage with a coil spring attached to the magnet. It is held in a vertical position on the coated steel and lifted away slowly until the magnet pops off the surface. The paint thickness is indicated by the position of the indicator on the calibrated scale. The attractive force of the magnet varies inversely with the paint thickness.

Banana gages (long, narrow instruments) represent another form of pull-off gage. They are more versatile and precise than pencil gages. A helical spring is stretched by manually turning a graduated dial, and a pin pops up when the magnet is lifted. At least one company sells an automatic gage with a dial that turns and stops automatically. Cheaper models have a rubber foot contact for the painted surface. More expensive models have a more durable tungsten carbide foot for greater durability and precision. "V" grooves are cut in the probe housing of these gages and the electrically operated flux gages described below to permit more accurate measurement of paint dry film thicknesses on cylindrical surfaces.

10.3.11.2 Flux Gages. Magnetic flux gages measure changes in the magnetic flux within the probe or the instrument itself. Flux changes vary inversely with distance between the probe and the steel. Mechanically operated instruments of this type have a horseshoe magnet that is placed directly on the coating, and readings are made from the position of a needle on a calibrated scale.

Electrically operated magnetic flux instruments have a separate instrument probe that houses the magnet. Thickness measurements are presented in a digital read-out. Some of these gages have a probe attached to the instrument to permit greater accessibility, especially in laboratory work. They may also have

attachments for strip recorders for repetitive work or alarms to produce sounds if minimum thicknesses are not met. For the paint inspector, these more sophisticated attachments are normally unnecessary.

10.3.12 Destructive (Nonmagnetic) Dry Film Thickness Gage.

There are several models of Tooke gage described in ASTM D 4138, Measurement of Dry Film Thickness of Protective Coating Systems by Destructive Means that measure paint dry film thickness on any surface by microscopic observations of precision-cut angular grooves in the film. The gage is not recommended with very soft or brittle films which distort or crumble, respectively, when cut.

A dark, thick line is first drawn on the painted surface for later reference under the magnifier. A groove is then firmly cut perpendicular across the line with a tungsten carbide cutter tip as it forms a tripod with two support legs. The width of the cut is determined visually using the illuminated magnifier portion of the instrument. Tips with three different cutting angles are available for use with films of thickness up to 50 mils. Visual observations are multiplied by 1, 2, or 10, depending upon the cutting angle of the tip, to determine the actual film thickness. Thicknesses of individual coats of a multi-coat system can be determined, if they are differently colored.

10.3.13 Holiday Detector.

Instruments for detecting pinholes and other flaws in coatings on metal surfaces are used mostly on waterfront and fuel storage and distribution facilities but should be used on freshly coated critical metal structures. Holiday detectors are available in two types: low and high voltage, as described in NACE RP0188.

10.3.13.1 Low Voltage Holiday Detectors.

Low voltage (30 to 90 volts) detectors are used on coatings up to 20 mils in thickness. These portable devices have a power source (a battery), an exploring electrode (a dampened cellulose sponge), an alarm, and a lead wire with connections to join the instrument to bare metal on the coated structure. A wetting agent that evaporates upon drying should be used to wet the sponge for coatings greater than 10 mils in thickness. The wetted sponge is slowly moved across the coated surface so that the response time is not exceeded. When a holiday is touched, an electric circuit is completed through the coated metal and connected wire back to the instrument to sound the alarm. Holidays should be marked after detection for repair and subsequent retesting.

10.3.13.2 High Voltage Holiday Detectors. High voltage (up to 30,000 volts or more) holiday detectors are normally used on coatings greater than 20 mils in thickness. The rule of thumb is to use 100 volts per mil of coating. The exploring electrode may consist of a conductive brush or coil spring. It should be moved at a rate not to exceed the pulse rate of the detector. If a holiday or thin spot in the coating is detected, a spark will jump from the electrode through the air space or a thin area of the coating to the metal. The resultant hole in the coating will locate the holiday or thin spot that requires corrective action.

10.3.14 Adhesion Tester. There are two basic types of testing for determining adhesion of coatings: the tape and the pull-off test. The tape test is mostly used in the field, and the pull-off test, in the laboratory. The tape test is most useful when adhesion is low. Thus, it is often used to determine whether an old coating has adequate adhesion to support another layer of paint, or whether there is compatibility between coating layers. This test cannot distinguish among good adhesion levels. The pull-off test is more time consuming to perform since a "dolly" or fixture must be glued to the surface of the coating. The test measures the tensile force needed to remove the fixture. Pull-off forces up to several thousand pounds per square inch can be measured.

10.3.14.1 Tape Adhesion Test. In the tape test, ASTM D 3359, an X or a lattice pattern is cut through the coating to the substrate. Special pressure-sensitive tape is applied over the cut and rapidly pulled off at an angle of 180 degrees. The cut area is then examined for extent of deterioration. A kit is available with a knife, chrome-plated steel template and tape for performing the test.

10.3.14.2 Pull-Off Adhesion Test. In the pull-off test, ASTM D 4541, a metal dolly is bonded to a coated surface at a perpendicular angle with an adhesive, usually a two-component epoxy. After the adhesive has fully cured, a force is gradually and uniformly applied to the dolly until it is detached from the coating (or until the desired pull-off level is reached). One type of pull-off tester has a hand wheel that is turned to apply the force. The hand wheel/ratchet spanner is tightened until the dolly is detached or a prescribed force is applied. Another type applies the pull force pneumatically with compressed gas. Machine application of pull produces more accurate results than manual application. In both cases, care must be taken to make sure the dolly and instrument are both aligned perpendicular to the coated surface. A horizontal surface is preferred.

10.3.15 Portable Glossmeter. Battery-powered, pocket-size gloss meters can provide accurate measurements in the laboratory or field. ASTM D 523, Specular Gloss, describes a method for measuring gloss in the laboratory which could be adapted for use with a portable device. Measurements can be made on any plane surfaces.

10.3.16 Hardness Tester. A series of hardness pencils (drawing leads) are available for determining rigidity or hardness of organic coatings on rigid substrates. The film hardness is that of the hardest lead that does not cause damage, as described in ASTM D 3363, Film Hardness by Pencil Test. The procedure is used to establish degree of cure, adverse effects of solvents from a wet layer upon a dry film, and softening effects caused by environmental exposure.

Section 11: ANALYSIS OF PAINT FAILURES

11.1 Definition. Organic coatings deteriorate and fail with time. Failure analysis does not concern itself with this type of deterioration. It is defined as an investigation to determine the cause or causes of premature deterioration of coatings or coating systems. It is obvious, however, that failure analyses are often also directed at obtaining additional information than that stated in the above definition. Thus, the failure analyst may also wish to determine the extent of the damage, whether all requirements of a specification of a contract or work order had been met, who might be responsible for the failure and thus be liable for repairs, or what is the best remedial action to correct the existing condition.

11.2 Documentation of Findings. Measurements, photographs, specimens, and other observations made at the job-site or later in the laboratory should be firmly documented with dates, locations, etc., because they may at a later time become legal evidence. Personnel conducting failure analyses should routinely follow the procedures necessary for such documentation to prepare for any eventuality.

11.3 Scope of Failure Analysis. Paint failure analysis can be conducted by anyone with a basic understanding of coatings. However, they are best conducted by someone specially trained for the work. This is particularly true if the investigation becomes part of a dispute, since credibility of the analyst may be a determining factor in a dispute. In some instances, an analysis need not be extensive, but care must be taken not to make important conclusions based on superficial observations. A complete paint failure analysis includes most or all of the following actions:

- a) Review of specification including modifications
- b) Review of supplier's data
- c) Review of inspector's daily reports
- d) Thoroughly documented on-site inspection
- e) Laboratory analysis of retained and/or field samples
- f) Analysis of data

g) Preparation of a report containing findings and conclusions

11.3.1 Review of Specification for Coating Work. The specification and the submittals required in the specification for the coating work should be thoroughly reviewed and understood. The specification states precisely the work that was to have been done and the methods and materials that were to be used, so that any deviations from them should become apparent. The review may also point out discrepancies or lack of clarity in the document that may have contributed to the failure.

11.3.2 Review of Supplier's Data. Supplier data sheets should be reviewed, because they describe the intended purpose of the coatings used, along with recommended surface preparation and application practices. They may also include compositional information that can be checked later by laboratory analysis to determine if the batch actually used was properly prepared.

11.3.3 Review of Inspector's Daily Reports. The inspector's daily reports should be reviewed, because they provide information about the conditions under which the work was accomplished and the quality of the surface preparation and coating application. Any compromises in the conditions required by the specification or recommended by the supplier may lead to early failure. These reports may also reveal field changes that were made to the original specification.

11.3.4 On-Site Inspection. Just as the inspector on the job, the person analyzing paint failures must have access to areas where failures have occurred. This may require ladders or lift equipment, lighting, or mirrors. The analyst should also have photographic equipment to document conditions and be skilled in its use. Scales should be used to show relative size, and permanent markings should be made on each photographic exposure for positive identification. Dates should also be placed on the photographs.

The analyst should have a standard kit of field test equipment including one or more thickness gages and calibration standards, a knife, a hand lens, and containers for samples. Obviously, he should be well trained in their use and use them systematically, as described elsewhere in this text. A container of methyl ethyl ketone (MEK) or other strong solvent may be useful in either determining paint solubility (e.g., verifying the general paint type or its complete cure) or to strip off a coating to examine the condition of the underlying surface or the thickness of the underlying galvanizing or other insoluble

coating. Standard forms for manually recording data or equipment for voice recording are also very useful. A failure analysis checklist can ensure that no important item is overlooked. Obviously, all items on the list may not be important at all times, but to inadvertently skip an important one may be a serious oversight.

11.3.5 On-Site Inspection Techniques. An overall visual analysis should first be made to determine the areas where the deterioration is most extensive and where any apparent deviation from specification may have occurred. This should then be followed by a closer examination as to the specific types of deterioration that may be present.

a) Use of a hand lens may provide information not otherwise visually apparent. All types of failure, including color changes and chalking, should be described fully. For example, does peeling occur between coats or from the substrate? Are blisters broken or filled with water? This detailed information may be necessary for finalizing conclusions as to the type of failure. The terms defined later in this section should be used to describe failures rather than locally used terms that may not be clear to other people. Care must be taken not to come to final conclusions until all the data are analyzed. It is a good practice to state at the inspection site that the final conclusions on causes of failure cannot be made until completion of laboratory testing.

b) Dry film thicknesses should be routinely measured and recorded, as any significant deviations from recommended thicknesses can be a factor contributing to coating failure. The procedure for measurement of these thicknesses required in the specification should be followed.

c) Other measurements that may be important are coating adhesion and hardness, since they may provide important information on application or curing of the coating. Adhesion can be easily determined with a simple tape test described in Section 9 or by using more sophisticated instrumentation (refer to Sections 8 and 9). Hardness can be tested in the field with a knife or special hardness pencils.

d) It is generally important to verify the identity of the finish coatings and occasionally the identity of the entire coating system. If wet samples of the paints used have been retained, they can be submitted for laboratory analysis for conformance to specification or manufacturer's data sheet. If these are not available, a simple solvent rub test may be useful

in determining whether the exterior coatings are thermoplastic, thermosetting, or bituminous. A cotton-tipped swab stick is dipped in MEK or acetone and rubbed against the paint surface. A thermosetting coating such as a vinyl which has been deposited on the surface by simple solvent evaporation will redissolve in the solvent and be wiped onto the cotton. A bituminous (coal tar or asphalt) coating will also behave in this manner, but it will impart a characteristic brown stain to the cotton. Properly cured multiple-component thermosetting coatings such as epoxies that cure by chemical reaction will not be affected by the solvent. These solvents can also be used at the job site to remove thermoplastic coatings to examine the condition of the underlying substrate. The presence of mill scale may establish the extent of surface cleaning. If rust is found, care must be taken to determine if it was present before painting or resulted from underfilm corrosion. Samples of the finish coat can also be removed by sanding and taken to the laboratory for identification as described in par. 11.3.6.

e) Once the various types of failure that may be present have been identified, the extent of each type of deterioration should be estimated. Standard block methods that help to quantify the extent of coating deterioration are described in ASTM F 1130, Inspecting the Coating System of a Ship. Two sets of drawings are used to illustrate failures. One set is used to identify the portion of the surface on which the paint is deteriorated. The other set is used to identify the level of deterioration within the deteriorated areas. For example, a fourth of the surface could exhibit blistering and within the areas 10 percent of the surface could be blistered.

11.3.6 Laboratory Testing. A more definitive laboratory analysis of deteriorated paint is generally desired and may become critical if the problem goes into litigation. Such analyses require several representative paint samples to be collected at the job site. Peeled and blistered paint is easily sampled, but it may be necessary to obtain samples from sound paint by scraping or sanding. Each sample should be placed in a sealed container and properly identified and dated. Chain of custody procedures (ASTM D 4840, Sampling Chain of Custody Procedures) should be used if litigation is involved.

If samples of wet paint used on the job are available, they can be tested by standard laboratory tests for conformance to any SSPC, Federal, military, or State specification referenced in the contract specification. If none of these standards was

referenced in the specification, the paints can be tested for conformance to manufacturer's listed composition or properties.

11.3.6.1 Microscopic Examination. Samples of paint collected at the job site should be examined under a light microscope. An edge examination may reveal the number of coats and the thickness of each coat. An examination of the surface may reveal fine cracking or other irregularities. Examination under a scanning electron microscope (SEM) can reveal much more detailed information about the paint film. Also, the SEM often has an attachment for energy dispersive x-ray analysis which can identify the metals and other elements in the pigment portion of small areas of the coating.

11.3.6.2 Spot Tests. There are several simple laboratory spot tests that can be run on samples of deteriorated paint collected at the job site. They generally provide specific information about the paint binder (ASTM D 5043, Field Identification of Coatings) or pigment. Special chemicals and training are usually required by the analyst.

11.3.6.3 Infrared Spectrophotometric Analysis. The most widely used technique in laboratory analysis of paint failures is the infrared spectrophotometry. The use of new Fourier transform infrared (FTIR) spectrophotometers permits much more versatility and precision than earlier instruments. The technique can identify the resin components of paints from the shapes and locations of their characteristic spectral peaks. It is highly desirable to separate the resin from the paint pigment before analysis, because the pigment may cause spectral interference. This is easy to do with thermoplastic but not thermosetting paints. Thermoplastic resins can be dissolved in solvents that are transparent in part or all of the infrared region, filtered to remove the pigment, and the solution placed in standard liquid cells or cast as films onto sodium chloride or other plates that are transparent in the infrared region. Thermosetting coatings can be pressed into potassium bromide pellets or their spectra measured using diffuse reflectance equipment. Although the pigment is not separated in these procedures, the spectrum of the pigment can often be separated from that of the total coating by the FTIR spectrometer. Spectra of field samples are compared against published standards or authentic samples. It should be remembered that exterior weathering may cause oxidation that may appear in spectral analyses.

11.3.6.4 Other Specialized Instrumentation. There are other specialized instruments that can be very helpful in failure analysis. These include emission spectroscopy, atomic absorption spectroscopy, and x-ray fluorescence instruments that can

identify and quantify the metals present in a coating. Their methods of operation are beyond the scope of this document.

11.3.7 Forming Conclusions and Preparing Reports. Field and laboratory data should be analyzed logically and systematically to form conclusions as to the causes of paint failure. No data should be overlooked, and the conclusions should be consistent with the data. The report should include conclusions and recommendations requested by the activity for which the analysis was made.

The report is perhaps the most important part of the failure analysis, because it presents the findings and conclusions of the investigation. No amount of good field or laboratory work will be useful unless it is presented well in the report. There must be a clear, systematic, and logical presentation of the findings, so that the conclusions are well supported. The report should not contain errors or otherwise be subject to challenge. Where conclusions are not firm, the extent of uncertainty should be stated.

11.4 Expert System for Failure Analysis. An expert system for failure analysis provides a systematic approach first to make a preliminary identification based on visual observations and then to verify it with supplementary information. The initial identification is based upon the answers to a series of questions designed to distinguish one type of failure from another. Decision trees 1 and 2 are used for this, one for surface defects and one for film failures. This same approach can be used in an expert system for a computer. The importance of a systematic approach cannot be overemphasized. One should be careful not to make permanent decisions on types and causes of failure until all the evidence is considered.

The first step in the identification of a coating failure is to determine which decision tree to use. Tree 1 for cosmetic defects should be used if only surface damage is present, i.e., if the surface coat has not been completely penetrated to the underlying coat or structural substrate. Tree 2 for film failures should be used if coating damage has completely extended through the surface coat.

After a preliminary decision of the type of failure has been made, look at the additional comments in the verification section below to obtain further support for this selection. If this information does not support the initial decision, reexamine the evidence or reconsider answers to the decision tree, until you are satisfied that you received the best overall answer.

Remember, answers are not always easily obtained in failure analysis, and there may be multiple types and causes of failure. Thus, one may in some cases have to be content with the most probable cause or causes of coating failure.

11.4.1 Cosmetic Defects. The following paragraphs further describe the cosmetic defects chosen in the initial decision.

11.4.1.1 Chalking. Chalking occurs only on exterior surfaces, since it is caused by the sun's ultraviolet rays. The loose chalk will be the same color as the coating, and, if it is severe, an undercoat may be visible. Chalking should not be confused with loose dirt which will not be the same color as the finish coat.

11.4.1.2 Mildew. Mildew may resemble dirt but generally grows in discrete colonies rather than being uniformly distributed. In addition, it can be bleached with household bleach, but dirt cannot. Also, it can also be identified microscopically by its thread-like (hyphae) structures and its groups of spherical spores. Mildew is usually black in color but some microorganisms on coatings may have a green or red coloration.

11.4.1.3 Dirt. Dirt may be tightly or loosely held. It can normally be removed by washing with detergent solution. However, it may resist washing, if the dirt became embedded in the wet or soft paint.

11.4.1.4 Uneven Gloss. Localized glossy spots may often be detected only if observed from a particular angle. They occur most frequently from spray application of heavy areas that do not penetrate into wood or concrete/masonry surface.

11.4.1.5 Blushing. Blushing is a defect from spraying fast-evaporating coatings, particularly lacquers such as vinyls and chlorinated rubbers, on hot, humid days. Condensation of moisture on the wet film dulls the finish to cause an opalescence.

11.4.1.6 Bleeding. Bleeding occurs when solvent-containing coatings are applied to a bituminous coating or pavement. The stronger the solvent and the slower its evaporation, the greater will be the tendency to dissolve the bituminous material and cause it to bleed to the surface of the finish. New asphalt pavements or toppings should be allowed to remain 4 weeks before marking with paint to allow evaporation of volatile materials in the asphalt.

11.4.1.7 Fading. Fading of paint pigments occurs greatest in the sunlight. Thus, there will be less fading of coatings under eaves and other shaded areas. It also occurs more with synthetic organic pigments than with naturally-occurring mineral pigments (earth tones).

11.4.1.8 Discoloration. Discoloration is caused by exposure of unstable pigments or resins to sunlight. Unstable resins like polymerized linseed oil may yellow. The only prevention is to use light-stable materials.

11.4.1.9 Pigment Overload. Pigment overload frequently results in a mottled appearance or a poor quality film. It can occur when attempting to tint a white paint to a deep tone. Latex paints are particularly susceptible to this problem. By specifying colors produced by the supplier, this problem can be avoided.

11.4.1.10 Checking. Early checking may be caused by improper formulation or application that causes the coating to shrink upon curing. Excessive thickness or rapid curing may be responsible. Aging will eventually cause checking of most coatings. It will often occur when existing paints are topcoated with more rigid finish coats that do not expand or contract as easily.

11.4.1.11 Dry Spray. Dry spray produces an uneven, pebbly finish with holidays. The holidays can be verified on a metal substrate with a holiday detector. It occurs most frequently when applying coatings with fast evaporating solvents on warm days or when the spray gun is held too far from the surface being painted.

11.4.1.12 Sagging. Sags may not permit complete curing of the body of oil-based coatings and so may be soft below the surface. Reduced film thickness in the areas where the sagging initiated may be detected using a magnetic thickness gage on steel surfaces and by using a Tooke gage on other surfaces.

11.4.1.13 Orange Peel. Orange peel is a defect of spray application. It usually is widespread, when it occurs, and is easily identified by its resemblance to the skin of an orange.

11.4.1.14 Wrinkling. Wrinkling occurs mostly with oil-based paints that are applied so thickly on hot days that the surface of the film cures rapidly to form a skin that does not permit oxygen to reach the interior of the film to cure it. The coating under the ridges is usually soft. Ridges generally occur in parallel rows.

11.4.2 Film Failures. The following paragraphs further describe the film defects chosen in the initial decision.

11.4.2.1 Crawling. Crawling, sometimes called bug eyeing or fish eyeing, occurs during coating application, frequently on contaminated surfaces. It can usually be detected at the time of application. The smooth, oval shapes resembling eyes are characteristic of crawling.

11.4.2.2 Alligatoring. The characteristic checkered pattern of cracked coating will identify alligatoring. The coating is quite inflexible and cannot expand and contract with the substrate. It is a special form of cracking or checking.

11.4.2.3 Intercoat Delamination. Intercoat delamination is simply the peeling of a stressed coat from an undercoat to which it is poorly bonded. It may occur in a variety of situations, but occurs frequently when a chemically curing coating such as an epoxy or a urethane has cured too hard to permit good bonding of a topcoat. It may also occur when coating a contaminated surface.

11.4.2.4 Intercoat Blistering. Intercoat blistering in a storage tank or other enclosed area is likely due to solvent entrapment. In water tanks or other areas exposed to water, the trapped solvent will cause water to be pulled into the blister. If the blisters are large, unbroken, and filled with water, it is sometimes possible to smell the retained solvent after breaking them. Intercoat blistering may lead to intercoat delamination.

11.4.2.5 Pinpoint Rusting. Pinpoint rusting is frequently caused by applying a thin coating over a high profile steel surface. A thin coating can be verified using a magnetic thickness gage. It may also occur when steel is coated with a porous latex coating system. Pinpoint rusting may initiate corrosion undercutting of the coating.

11.4.2.6 Cracking. Cracking is the splitting of a stressed film in either a relatively straight or curved line to an undercoat or the structural substrate. Cracking may occur from rapidly curing coatings such as amine-cured epoxies. Mudcracking is a more severe condition caused by rapid drying, particularly by heavily pigmented coatings such as inorganic zincs. It also occurs with latex coatings applied too thickly on hot days. On wood, too thick or too inflexible a film (usually a buildup of many layers) can cause cracking perpendicular to the grain of the wood.

11.4.2.7 Blistering to Substrate. The blisters that arise from the substrate may be broken or unbroken. If broken, they may lead to peeling and be hard to identify. Blistering to wood or concrete/masonry substrates may be caused by moisture in the substrate.

11.4.2.8 Peeling. Peeling is the disbanding of stressed coatings from the substrate in sheets. It is generally preceded by cracking or blistering.

11.4.2.9 Flaking (Scaling). Flaking or scaling is similar to peeling, except the coating is lost in smaller pieces. Flaking of aged alkyd coatings occurs commonly on wood.

11.4.3 Examples of Using Decision Trees. The decision trees 1 and 2 (Figures 24 and 25) can best be understood by using examples.

11.4.3.1 Example of Surface Defect. This example is a surface defect that does not penetrate the finish coat so that use of decision tree 1 is required. We start with Question 1, "Does detergent washing remove the defect?" In our example, the answer is "Yes," so we proceed to Question 2, "Does wiping with a dry felt cloth remove defect?" This time the answer is "No," so we proceed to Question 3, "Does defect disappear when treated with household bleach?" In our example, the answer is "Yes," so we have tentatively identified the defect as "Answer 2" mildew.

11.4.3.2 Example of a Film Defect. This example is a defect that penetrates the finish coat so that use of decision tree 2 is required. We start with Question 10, "Do oval voids that originate at time of coating application expose an undercoat or the structural substrate?" In our example, the answer is "No," so we proceed to Question 11, "Does the failure expose only an undercoat?" This time the answer is "Yes," so we proceed to Question 12, "Which best describes the failure?" In our example, the answer is "Peeling topcoat to expose undercoat," so we have tentatively identified the defect as "Answer 17" intercoat delamination.

DECISION TREE FOR COSMETIC (SURFACE) DEFECTS, DAMAGE DOES NOT COMPLETELY PENETRATE FINISH COAT

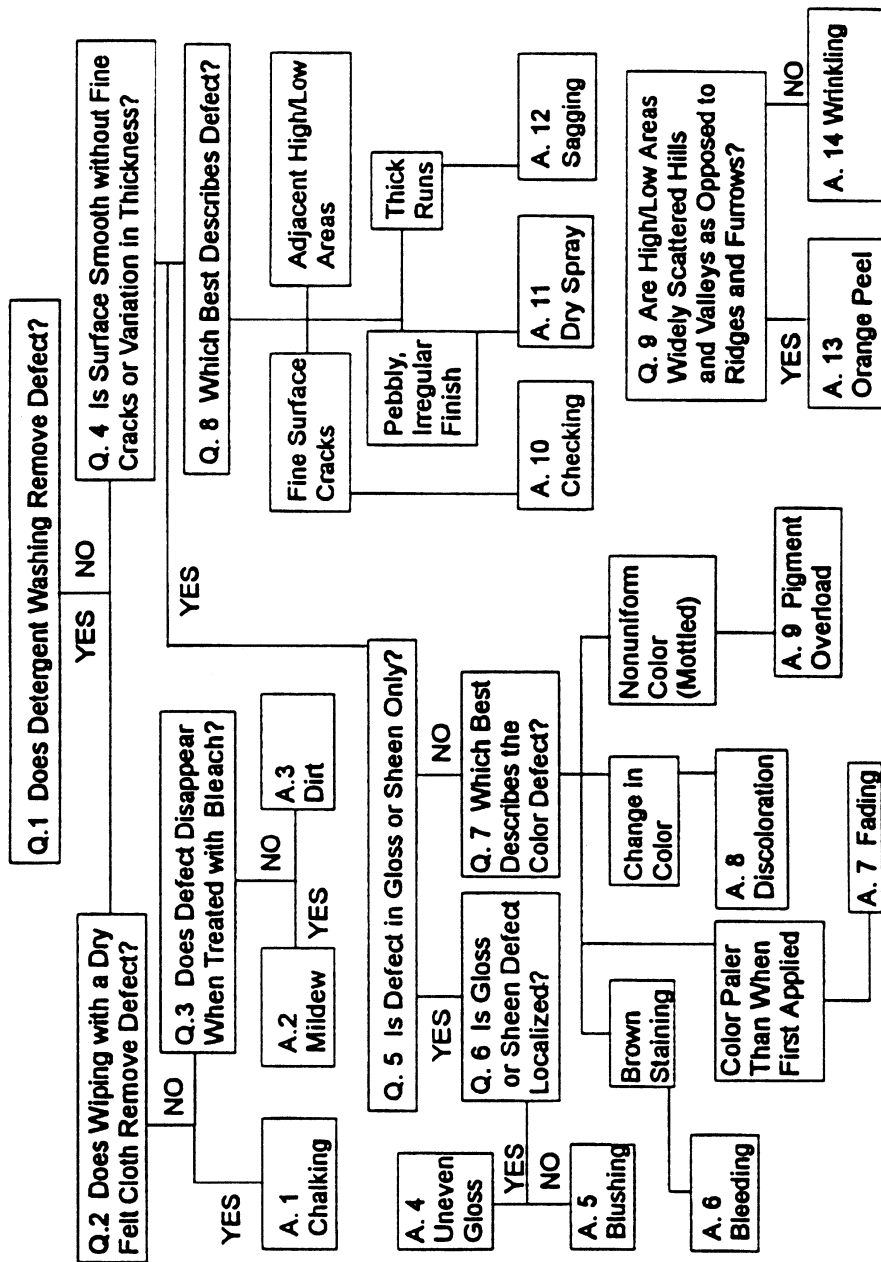

Figure 24
Decision Tree 1: Support for Analysis of Coating Failures That Do Not Penetrate the Finish Coat

DECISION TREE FOR FILM DEFECTS, DAMAGE PENETRATES FINISH COAT

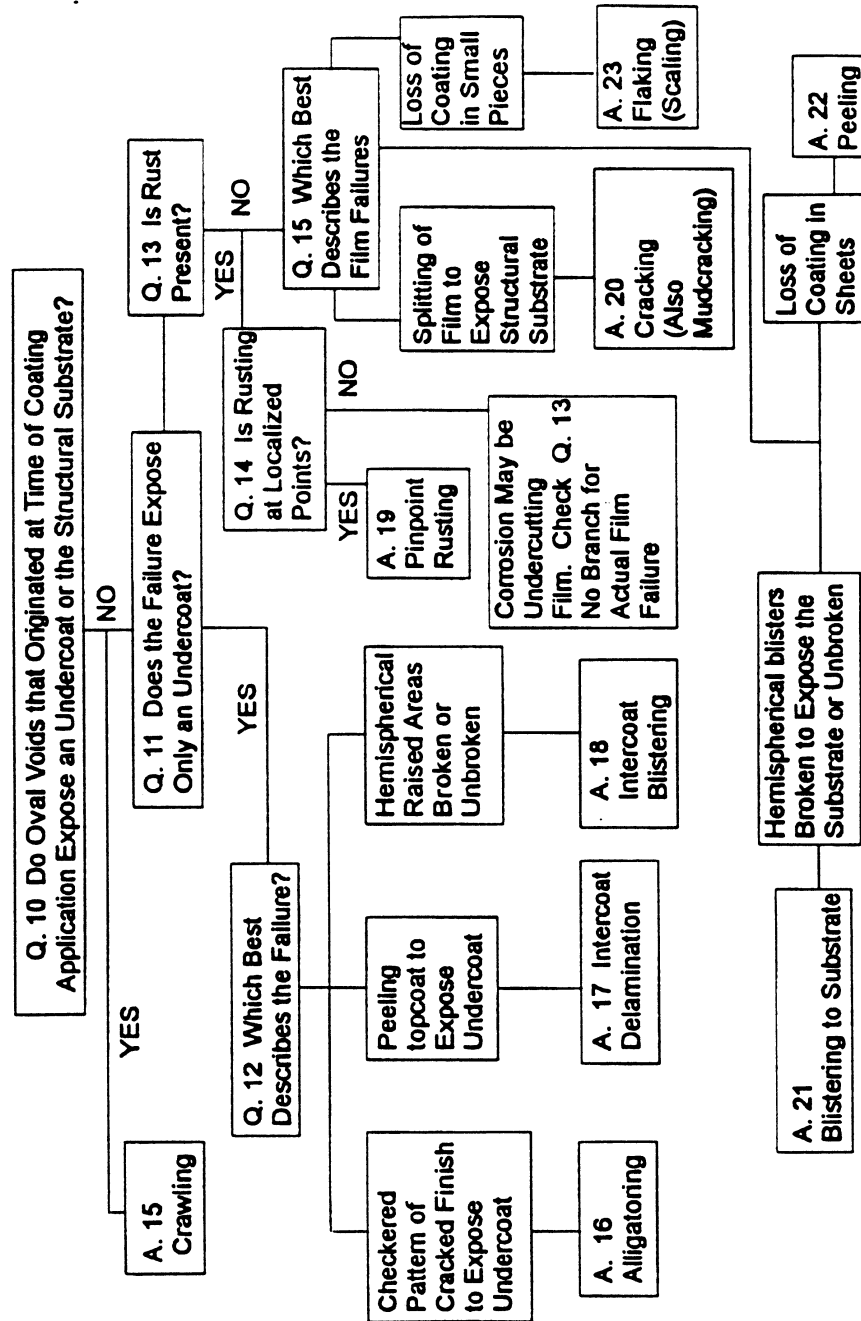

Figure 25
Decision Tree 2: Support for Analysis of Coating Defects That Penetrate the Finish Coat

Section 12: PROGRAMMING MAINTENANCE PAINTING

12.1 Definitions of Programmed Painting and Maintenance Painting. Paint programming is a systematic planning process for establishing when painting is required, what painting should be done, by whom, at what times, and in what manner. Maintenance painting is a vital adjunct to programmed painting. It is defined as a field procedure for maintaining existing coatings in an acceptable condition.

12.2 Components of Programmed Painting. There are three basic components of successful paint-programming plans: plans for initial design of the facility, plans for monitoring conditions of structures and coating systems, and plans for maintenance painting. Each plan must be prepared properly and completely for the total program to be successful.

Programmed painting can best be implemented as a computer program. This program will contain the initial design data, data on the conditions of the structures and their coating systems obtained from an annual inspection report, and recommended maintenance painting schedules and procedures. The latter should include cost estimates for each item of work so that funding can be requested well in advance of the time it will be spent. Cost estimating programs for construction work are available in the Construction Criteria Base (CCB) (National Institute of Building Sciences, Washington, DC) and proprietary sources.

12.2.1 Initial Design. The design of both new structures and their coating systems is critical to achieving maximum life of each.

12.2.1.1 Structural Design. Structures should be designed so that they are easy to coat initially and to maintain in an acceptable condition. Common structural design defects include:

a) Contact of Dissimilar Metals. The more active metal will rapidly be consumed by galvanic corrosion to protect the less active metal. This includes contact of steel and stainless steel.

b) Water Traps. Structural components that collect rainwater corrode more rapidly. These components should either be turned upside down or have weep holes of sufficient size and correct placement drilled in them. Weep holes should be as large as possible and placed at the bottom of the structure.

c) Configurations That Permit Vapors or Liquids to Impinge on Structural Components. Structures such as steam lines.

d) Configurations Restricting Access. Structures that restrict access for painting receive poor quality maintenance.

e) Designs Creating Crevices. Crevices are difficult to coat, and the oxygen deficiencies in them produce a type of galvanic corrosion.

f) Other Difficult to Paint Surfaces. Sharp edges and welds should be ground, pits should be filled, and corners should be avoided.

12.2.1.2 Design of Coating System. The original coating system must be designed to be compatible with both the environment in which it is to be located and the substrate to which it is to be applied. Sections 4 and 5 of this handbook list systems that meet this requirement and are cost effective. As far as possible, it is desirable to specify coating systems that are easy to apply and maintain. It is always preferable to do the surface preparation and the paint application in the controlled environment of a shop as compared to the field. If this is not possible, this work should be accomplished at the work site before rather than after erection.

12.2.2 Plan for Monitoring Conditions of Structures and Their Protective Coatings. Annually, each coated structure at each military activity should be inspected for deterioration of both the substrates and their coatings. Both the types and the extent of deterioration should be noted, and the generic type of the finish coat should be determined if it not already known. An estimate should also be made as to when structural and coating repairs should be made to prevent more serious damage. Other structures at the activity that require the same type of maintenance should also be noted, since it would be more economical to include as many structures as appropriate in a single contract. An example of an inspection form which has been successfully used for routine inspections and could be modified to meet an installation's needs is shown in Figure 26.

12.2.2.1 Determining the Type of Coating Failure. The type of coating failure can be determined by following the procedure given in Section 11.

12.2.2.2 Determining the Extent of Coating Failure. In maintenance painting, it is necessary to determine the extent of coating failure to permit realistic bidding for the repair work.

To do this, both the severity of the deterioration and its distribution must be defined. The level of severity will indicate whether only the finish coat or other coats are involved in the deterioration and how it can best be repaired. If the distribution is limited, spot repairing is likely to be practical; if it is extensive, it is probably best to remove all the coating and repaint.

Standard block diagrams for estimating coating deterioration on ships for "Overall Extent" and "Extent Within Affected Areas" are generally also appropriate for shore structures. They are described in ASTM F 1130. First, draw an imaginary line enclosing all deterioration and select the standard "Overall Extent" diagram that best matches the imaginary area. Then, select the standard "Extent Within Affected Area" diagram that best matches the areas within the imaginary line. The number and letter of the selected diagrams establish the extent of deterioration. Whatever system is used to determine the extent of deterioration, it should utilize a standard format so that evaluations of different structures can be compared and priorities can be established.

It is also important in maintenance painting to determine precisely the amount of loose and peeling paint to establish the amount of work to be done. This will eliminate any controversy over a "site variation," i.e., the contractor claiming that there was much more work necessary than described in the specification. It is a standard practice to define "loose and peeling paint" as that paint that is easily removed with a dull putty knife.

12.2.2.3 Determining the Generic Type of the Finish Coat. Once a painting program is set up, the identifications of paints being applied will automatically be entered into the database. If the generic type of the finish coat is not known, it can be determined by infrared spectrophotometric analysis as described in Section 11. The general compatibility of a coating can be determined by the solvent rub test, also described in Section 11.

12.2.3 Types of Maintenance Painting. In planning maintenance painting, it is first necessary to determine the general scope of the work. There are four different approaches to maintaining an existing coating in an acceptable condition:

a) Cleaning only to restore to an acceptable condition. This may be accomplished by pressure washing or steam cleaning.

Structure Number _____	Date _____
Reason for Inspection _____	
Inspector's Name _____	
Substrate:	Component:
Wood	Siding
Aluminum	Window Frame
Concrete	Door
Transite	Door Pocket
Steel	Door Frame
Galvanized Steel	Eaves
Other _____	Other _____
Appearance:	Deterioration:
Chalking	Cracking
Fading	Blistering
Mildew	Peeling
Other _____	Other _____
MEK Rub Test:	Evaluation (1=good, 4=bad):
- (no effect)	1
+	2
++	3
+++ (large effect)	4
Suspected Binder Type:	Samples Collected:
Alkyd	Chip Sample
Latex	Photograph
Epoxy	
Factory Finish	
Other _____	

Figure 26
Coating Condition and Identification Form

b) Spot repair (priming and topcoating) of areas with localized damage but otherwise sound paint. This should be done before the damage becomes more extensive.

c) Localized spot repair plus complete refinishing with topcoat only. This should be done when localized repair only would produce an unacceptable patchy finish.

d) Complete removal of existing paint and total repainting. This should be done when the damage is so extensive that types "b" or "c" are impractical or uneconomical.

Repair of exterior coatings may not be warranted with the first appearance of weathering, but deterioration should not proceed to the point that damage occurs to the substrate, or more costly surface preparation or application techniques become necessary. If lead-containing paint is present, the costs for paint repair or removal will be much more expensive. If the paint can be maintained in place, a great deal of savings will result. New restrictions on abrasive blasting and other surface preparation techniques may also significantly increase total costs. Thus, scheduling of repairs should be made to avoid such costly operations.

12.2.4 Plan for Maintenance Painting. The plan for maintenance painting includes selection of the surface preparation, application, and inspection methods and the materials to be used.

12.2.4.1 Selecting Materials for Maintenance Painting. For localized repairs to an otherwise sound coating system (12.2.3 types "b" and "c"), it is wise to repair a damaged coating system with the same coating previously used or one of the same generic type or curing mechanism to avoid incompatibility. If in doubt as to the compatibility of a paint to be applied to an existing finish, apply a small patch to it and inspect it after 2 to 3 days for any bleeding, disbanding, or other sign of incompatibility.

For total recoating (12.2.3 type "d"), select the coating as described for new work in Section 4 or 5.

12.2.4.2 Surface Preparation for Maintenance Painting. For making localized repairs, it is best to use the surface preparation methods for different substrates described in Section 6. It may be more practical or necessary, however, to use hand or power tools rather than abrasive blasting where the amount of work to be done is small, or where abrasive blasting would contaminate an area.

Loose and peeling coating should be removed, and the adjacent intact coating should be sanded to produce a feathered edge and roughened paint surface extending 2 inches beyond the repair area. The feathered edge will produce a smoother transition between the old and new paint and roughening the adjacent intact paint will permit good adhesion of the new primer.

Feather edging of steel may be accomplished by blasting with a fine abrasive (e.g., 60 mesh grit or finer) with the nozzle held at a low angle about 3 or 4 feet from the surface. However, even fine abrasive may damage adjacent coating. Thus, it is best to determine if there are any adverse effects with a surface preparation procedure before proceeding with it.

12.2.4.3 Application for Maintenance Painting. Spot application of paint in maintenance painting is usually done by brush or spray, as the painter determines to be most efficient. Brushing of the primer is usually preferred where the surface is rough or otherwise difficult to paint. Patches should be extended 2 inches beyond the areas of damaged coatings where the adjacent intact paint has been previously roughened.

12.2.4.4 Inspection of Maintenance Painting. Inspection of maintenance painting usually consists of visual inspection for workmanship, dry film thickness, and adhesion. Fuel tanks and lines, waterfront structures, and other critical structures should also be tested for holidays (imperfections in the coating). These inspection procedures are described in Section 9.

12.2.5 Scheduling the Work. By planning work well in advance, it is possible to schedule it at a time when minimum inclement weather is expected. It may also be possible to schedule it when there will be less interference with other trades doing construction work or personnel utilizing the structures.

Section 13: GENERAL SAFETY PRACTICES DURING PAINTING OPERATIONS

13.1 Introduction. This section discusses general safety concerns during painting operations and appropriate actions to be taken to protect those conducting these operations and others in the immediate area. Installation safety and industrial hazards offices should be consulted to determine detailed requirements for worker safety, including protection from toxic materials. General concerns will be discussed, much as they are discussed for safety paint application in SSPC PA 3, Safety in Paint Application. OSHA provides requirements for safety in the workplace. These requirements include:

29 CFR 1910.106/29 CFR 1926.152, Flammable and Combustible Liquids
29 CFR 1910.1200/29 CFR 1926.59, Hazard Communication
29 CFR 1910.146, Permit-Required Confined Spaces
29 CFR 1910.151, Medical Services and First Aid
29 CFR 1910.25, Portable Wood Ladders
29 CFR 1910.26, Portable Metal Ladders
29 CFR 1910.28, Safety Requirements for Scaffolding

Written policies are available at installation safety offices. These offices are responsible for providing necessary safety support, and it is important that personnel interact freely and positively with them in a total safety program. Attitude is of great importance in ensuring a safe working environment.

13.2 Standard Operation and Safety Plans. Every operation that involves any type of hazard should have a standard operating plan incorporating safety and health considerations. Contracted operations should have safety and health requirements clearly addressed in the contract specifications. Personnel have the right to learn of any unsafe or unhealthful conditions or operations that they will be involved with and to receive training or equipment necessary to conduct their work safely. Personnel must also be able to report hazardous conditions and conditions suspected of being hazardous without fear of retaliation. Workers, on the other hand, also have the responsibility of conducting their work in a safe and healthful manner, correcting or reporting unsafe or unhealthful conditions, and wearing appropriate personal protection equipment. This includes reducing exposures as much as possible. Only necessary personnel should be present in the hazardous areas.

13.3 Hazard Communication. The best way to protect yourself from chemical products used in painting operations is to know their identification, the hazards associated with them, and their

proper and safe use. Every employer must provide this information to his employees. Each container of hazardous material must be labeled to identify its contents. Unlabeled products should never be used. Other important information on chemicals, including health and safety data, precautions for handling, and emergency and first aid procedures, can be obtained from the material safety data sheet (MSDS) for the product. These sheets are required to be present when hazardous materials are being shipped, stored, or used in any operation. Finally, the activity must have a written program providing personnel with information about the hazardous chemicals used in each operation and an inventory of hazardous chemicals on site. The activity must also provide employees with necessary safety training.

13.3.1 Labels. Labels should be replaced, if they are torn, hat, or illegible. When materials are transferred to other containers for easier use, these containers must also be properly labeled. Labels usually contain the following information:

- a) Complete identification - may include several alternative names
- b) Basic warnings - list hazardous chemicals and precautions
- c) First aid requirements - what to do when splashed on eyes or skin
- d) Fire actions - how to properly extinguish fires
- e) Treatment of spills - equipment and materials for cleaning up spills
- f) Handling and storage procedures - safety equipment and practices for proper handling
- g) Disposal procedures - describe methods for safe and legal disposal

13.3.2 Material Safety Data Sheets. MSDSs provide the following information:

- a) Chemical identification - identify chemicals present
- b) Hazardous ingredient data - list hazardous chemicals and safety limits

- c) Physical data - describe odor, appearance, etc., of chemicals
- d) Fire and explosion data - list flash point and extinguishing media
- e) Health hazards - symptoms of overexposure and emergency action
- f) Reactivity data - stability and reactivity with other chemicals
- g) Spill or leak procedures - clean-up and disposal procedures; always notify safety office
- h) Special protection - necessary respirators, clothing, eye protection, etc.
- i) Special precautions - special handling precautions, including safety signs and standby clean-up kits

Note: Specific requirements for personal protective equipment and use of the chemical should be based on a local evaluation by an industrial hygienist or health professional.

13.4 Toxicity Hazards. Many toxic materials may be encountered during cleaning and painting operation, such as organic solvents and lead- and chromate-containing pigments. Personnel working with toxic materials should be knowledgeable about how to protect themselves from them.

13.4.1 Entrance of Toxic Materials Into Body. Although toxic materials can enter the body during any part of a coating operation, surface preparation and coating application activities may present the greatest hazard. Toxic materials can enter the body by three different routes:

- a) Inhaling in the lungs
- b) Ingestion through the mouth
- c) Absorption through the skin

13.4.1.1 Inhalation. Toxic vapors or suspended particles inhaled into the lungs may be rapidly taken into the rest of the body. Individual solvents in blends in paints vary widely in human toxicity. Exposures can be reduced with ventilation and respirator protection.

13.4.1.2 Ingestion. Ingestion through the mouth usually occurs from contaminated hands not washed before eating, drinking, or smoking. Good personal hygiene (hand washing, avoidance of clothing contamination and keeping tools/surfaces clean) should be practiced even when gloves are used.

13.4.1.3 Skin Absorption. Skin absorption must occur through contact. This can be minimized by use of protective clothing. Contaminated clothing should be removed and disposed of at the job site and be completely cleaned, and the contaminated person should thoroughly shower before leaving the job site. The appropriate protective clothing is paramount to preclude significant skin contact as some chemicals easily permeate (pass through) the protective material.

13.4.2 Types of Toxic Materials. Toxic substances are of four major categories:

- a) Irritants - inflame eyes, nose, throat, and lungs
- b) Asphixiants (e.g., carbon monoxide, nitrogen) - Interfere with oxygen assimilation or displaces available oxygen to breathe
- c) Nerve poisons (organic solvents, lead compounds, etc.) - attack nervous system
- d) Systemic poisons - affect heart, liver, kidney, or blood forming organs

13.5 Respiratory Hazards. There are four types of respiratory hazards:

- a) Dusts - dry particles from grinding and blasting operations
- b) Mists - liquid particles from cleaning and spraying operations
- c) Gases and vapors of liquids - evaporated cleaning or paint solvent

d) Oxygen deficiencies - especially in confined areas

Dusts include smoke particles from combustion. Gases and some particles may not be seen by the naked eye. Any of these products resulting from painting operations may require a cartridge-type respirator. Specific recommendations for respiratory protection should come from a workplace evaluation of potential exposures.

13.6 Hazards in Different Painting Operations. Painting procedures may include one or more of the following hazardous operations: surface preparation, paint application, and working in high, confined, or remote places.

13.6.1 Surface Preparation. Surface preparation hazards occur in abrasive and water blasting operations, mechanical cleaning, chemical cleaning, and high temperature operations. Protection of workers and the environment from dust containing toxic metals (such as lead, cadmium, or chromate compounds) produced during removal of old paint is discussed in Section 3.

13.6.1.1 Abrasive and Water Blasting. Abrasive and water blasting are by far the most dangerous operations concerned with surface preparation for painting. High-pressure nozzles (over 100 psi for abrasive and over 30,000 psi for water blasting) pose major threats. Hoses and couplings must be checked for soundness, and the pot pressures must be checked to ensure that the maximum allowable pressures are not exceeded. The blast nozzle must have a deadman valve, so that it will automatically shut off, if it is lost by the blaster. No attempt should be made to override this or other safety devices. No safety omissions should be permitted, even for very small blasting jobs. The blasting area should be posted for no admittance, and the pot tender located in a protected area behind the blaster, so that no one is in the vicinity of the blaster. Each person in the operation should wear the proper safety equipment, including an air-supplied respirator (type CE) specifically designed for the blaster.

Isolation from the blaster and use of deadman valves are also important during water blasting. Electrical operations should be shut down at that time to prevent electrical shock. Care should also be taken to avoid slipping on wetted surfaces.

13.6.1.2 Mechanical Cleaning. Grinders, sanders, and other powered cleaning tools require special attention to meet the safety provisions of Subpart P of OSHA Standard 29 CFR 1910. They should have safety shields or devices to protect eyes and

fingers. OSHA regulations do not permit the use of faulty hand and power tools such as cracked grinders and wheels or damaged rotary brushes. Power tools should only be operated as recommended by the manufacturer.

13.6.1.3 Chemical Cleaning. Chemical cleaning is inherently dangerous and requires special precautions. Chemicals must be properly labeled (refer to par. 13.3.1), stored, and used.

Chemicals should be stored off the floor in a secured and ventilated room separated from other chemicals with which they may react. Any shelving used for storage should be secured to the wall and have a lip on each shelf to prevent being accidentally knocked onto the floor.

Chemicals should be used in accordance with written standard operating procedures or the manufacturer's instructions. Proper eye, face, hand, and skin protection should be taken by using appropriate chemical protective clothing, eye/face equipment and following recommended operating procedures when working with caustic chemicals or solvents. Where the eyes or body of any person may be exposed to corrosive materials, suitable facilities for quick drenching or flushing of the eyes (eye washes) and body (deluge showers) shall be provided in the work area for immediate emergency use. Contaminated personnel or the work areas should be appropriately cleaned and treated as soon as possible. Spill kits and instructions for their use should be available for each type of chemical.

13.6.1.4 High Temperature Operations. High temperature cleaning can be achieved with steam, flame, or heat guns. They should be thermostatically controlled and used only where appropriate and according to standard operating procedures. Insulated gloves should be used where necessary to protect hands from heat.

13.6.2 Painting Operations. Hazards occur during storage, mixing, and application of paints.

13.6.2.1 Storage of Paints. Coating materials should be stored off the floor under cover in secured and well ventilated areas away from sparks, flames, and direct sunshine. The temperature should be well below the flash point of stored products. Flash point is the minimum temperature at which a liquid gives off enough vapor to become ignited in the presence of a spark or flame. Flammable liquids such as turpentine and toluene have flash points below 100 degrees F; combustible liquids have flash points of 100 degrees F or greater. The flash points of

individual solvents vary greatly. So do the explosive limits - the concentration range in air at which combustion may occur.

Any shelving used for storage should be secured to the wall and have a lip on each shelf to prevent being accidentally knocked onto the floor. Equipment for removal of spills should be present.

13.6.2.2 Mixing and Applying Paints. Mixing and application operations have associated spill, fire, and toxicity hazards. Eye protection, gloves, and other appropriate equipment and clothing should be used during paint mixing operations. Individual solvents in blends in paints vary widely both in solvency and in human toxicity. They can remove moisture and natural oils from the skin to make it more sensitive to other irritants.

a) When mixing and applying paints, the following precautions should be observed:

- (1) Protect eyes, face, hands, and skin
- (2) Keep paint well below flash point
- (3) Use in well ventilated areas. Consult the facility's safety office, if in doubt, for evaluation of the work space
- (4) Use slow-speed stirrers to prevent buildup of static charge
- (5) Permit no matches, sparks, or flames in area
- (6) Ground equipment and work

b) When spraying paint:

- (1) Ground equipment and metal work
- (2) Use only non-sparking tools
- (3) Permit no matches, open flames, or smoking in the area
- (4) Perform in a well ventilated area or in an approved spray

Airless guns should only be used by trained personnel and with protective guards because, at the high pressures (over 2000 psi), paint droplets can penetrate flesh. They should never be pointed at any part of the body, and their nozzle guards should never be removed.

13.6.3 Work in High, Confined, and Remote Places. Work in high, confined, and remote places presents special hazards.

13.6.3.1 Work in High Places. Working safely in high places requires the proper use of equipment designed to provide access to the work site. Safety requirements for ladders, scaffolding, and stages can be found in OSHA Safety and Health Standards (29 CFR 1910), Paragraphs 1910.25 (Portable Wood Ladders), 1910.26 (Portable Metal Ladders), 1910.28 (Safety Requirements for Scaffolding), and 1910.29 (Manually Propelled Ladder Stands and Scaffolds (Towers)).

a) General requirements for ladders used in painting operations include

split (1) Do not use if rungs/steps are loose, bent, or

(2) Keep ladders away from power lines

(3) Never use as horizontal scaffold members

(4) Use only as intentionally designed

b) General requirements for scaffolds include:

(1) The footing/anchorage shall be sound and rigid (do not use bricks, boxes, etc., to support)

(2) Have rigid guard rails (never ropes) and toeboards or rails

(3) Keep them clean and free of abrasive, mud, grease, and other debris

(4) Remove unnecessary equipment

(5) Keep platforms level at all times

(6) Regular inspection and repair, as necessary

height (7) Never use ladders on their platforms to add

(8) Do not move when occupied

c) Additional requirements for swing (suspended) scaffolds suspended by block and tackle are:

- (1) Secure life lines to personnel on them
- (2) Never allow them to swing freely
- (3) Limit to two the number of personnel on them
- (4) Follow OSHA requirements for suspension

d) Additional requirements for rolling scaffolds are:

- (1) Always set caster brakes when in a fixed position
- (2) Never ride while moving
- (3) Remove materials from platform before moving

Permanent scaffolding should be built for routine maintenance operations on aircraft or other standard configurations. Powered lift platforms or boom machines are often used to reach high places. Some extend as high as 100 feet. Scissor lifts, the most common type, only go straight up. Booms can provide greater access where there are obstructions in the way. Continuous forced-air ventilation may be used to control any hazardous atmosphere. Gas monitoring during the operation may be necessary where unsafe conditions could develop. When painting bridges, towers, or other tall structures, safety nets or harnesses should be utilized. They not only provide safety but also result in better workmanship. Safety harnesses are much preferred to safety belts because they distribute the shock from the safety line. Some harnesses have breakaway sections to further distribute the shock. Suppliers of harnesses provide detailed instructions for proper use.

13.6.3.2 Confined Areas. Confined areas such as fuel storage tanks, boilers, and utility tunnels present the following hazards:

- a) Buildup of flammable or explosive atmospheres or materials
- b) Buildup of toxic atmospheres or materials
- c) Insufficient oxygen to support life

d) Excess oxygen posing fire or explosion hazard

Confined areas being cleaned or painted should be well ventilated to prevent the accumulation of toxic or combustible airborne contaminants. Mechanical equipment should be grounded, along with conductive substrates being cleaned or coated, to prevent sparking. Otherwise, an explosion may occur.

Confined spaces with limited ventilation and access may have hazards that are not easily detected. They should be checked for safety requirements before entering. Specific safety requirements for confined spaces can be found in OSHA Safety and Health Standards (29 CFR 1910) Paragraph 146 (Permit Required Confined Spaces). Paints with "safety solvents" (relatively high flash points) should be used in these areas. Hand and power tools and other electrical equipment including lighting should be non-sparking and explosion-proof. Because paint solvent vapors are heavier than air, ventilation of confined spaces requires exit of contaminated air from the lowest point. Other special considerations may apply. Installation safety offices generally provide guidance and support for confined space operations.

13.6.4 Remote Areas. When doing field work at remote locations, personnel should have a response plan for emergencies. Access to a telephone and medical treatment should be established. Knowledge of first aid, especially CPR, for immediate action is also beneficial.

13.7 Personal Protective Equipment. Hazards in painting operations can be greatly reduced by use of protective clothing, respirators, and other personal protective equipment.

13.7.1 Clothing. Protective garments must resist chemical attack from three different routes of entry:

- a) Permeation - chemical works its way through the suit
- b) Penetration - entry through physical imperfection (damage)
- c) Degradation - properties of material chemically degraded

Selection of the chemical protective clothing must be based on the chemical, the operation (i.e., need for abrasion resistance), and the effectiveness of the clothing material as a barrier against the chemical. Contaminated clothing should be discarded at the job site or thoroughly cleaned before reuse.

Personnel exposed to contamination should thoroughly shower and put on clean clothes before leaving work area. Torn clothing should not be worn, because it can get caught in machinery or on structural projections. Trouser cuffs and ties present a similar problem.

13.7.1.1 Gloves. Gloves come in different lengths and chemical compositions. The length should provide full protection, and the material should be resistant to the chemicals and materials with which it will come into contact. Selection of the right work glove can protect you from unnecessary injury or contamination. Commonly used protective gloves include:

- a) Disposable gloves - usually lightweight plastic; protect from mild irritants
- b) Fabric gloves - cotton or other fabric; improve grip; minimal protection from contaminants
- c) Rubber gloves - may also be of different plastics; protection from chemical contamination
- d) Leather gloves - protect from abrasion
- e) Metal mesh gloves - protect from cuts/scratches; used with cutting tools
- f) Aluminized gloves - insulates hands from intense heat

13.7.2 Protective Headgear. Head injuries can be very devastating and can result in brain damage or death. Selection of the proper head protection for different hazards is especially important. Protective headgear includes:

- a) Hard hats
- b) Bump hats
- c) Hair covers

13.7.2.1 Hard Hats. Hard hats are made of rigid, impact-resistant, nonflammable materials such as fiberglass or thermoplastics. A network of straps and harnesses holds the shell on the head and serves as a cushion. A full-brimmed hard hat provides general protection to the head, neck, and shoulders,

while the visored brim which does not, is often used in confined spaces. Hard hats must be worn in areas designated to require them.

13.7.2.2 Bump Hats. Bump hats are made of lightweight plastic that only protect the head from minor bumps. They should be worn only where there are minor head hazards and never as a substitute for a hard hat.

13.7.2.3 Hair Covers. Hair covers are made of breathable fabric or lightweight materials and are adjustable to fit properly. They are intended to prevent hair from becoming caught in moving machine parts.

13.7.3 Eye Protection. Installation safety offices have eye protection equipment available in many forms to protect eyes from flying particles, dust, sparks, splashes, and harmful rays. The appropriate type of eye protection should be used for each job.

13.7.3.1 Safety Glasses. Safety glasses have impact-resistant frames and lenses that meet OSHA and American National Standards Institute (ANSI) standards. Safety glasses may also have side shields, cups, or tinted lens to provide additional protection. Assistance in procuring safety glasses with prescription lenses may be available at the safety office. Safety glasses should be cleaned as described by the supplier and stored in a clean, dry place available for use when needed.

13.7.3.2 Safety Goggles. Safety goggles may be impact resistant, or provide chemical splash protection or optical radiation protection. The appropriate goggle should be procured and used for that purpose only. Goggles form a secure seal around each eye to provide protection from all sides. They may have direct or indirect ventilation to eliminate fogging.

13.7.3.3 Safety Shields. Safety shields or helmets have sheets of clear, resistant plastic to protect the face from splash or flying particles during grinding and welding operations or when working with molten materials. Safety shields are ordinarily worn with goggles or safety glasses to provide additional protection.

13.7.4 Hearing Protection. Hearing loss occurs over time from repeated exposure to excessively loud noises. Muffs, plugs, and canal caps offer a variety of devices to protect our hearing. Check the noise reduction rating (NRR) provided with each device to determine its noise protection capabilities.

13.7.4.1 Ear Muffs. Ear muffs come in a variety of styles. Most have spring-loaded head bands to secure them in place covering the entire ear. Ear muffs can reduce noise levels by 15 to 30 decibels.

13.7.4.2 Ear Plugs. Ear plugs of deformable rubber or plastic materials are positioned in the outer part of the ear. Ear plugs may be disposable or reusable. The latter should be cleaned and properly stored after use.

13.7.4.3 Canal Caps. Canal caps (headband plugs) close off the ear canal at its opening. A flexible headband ensures a close fit. Canal caps must also be cleaned and properly stored after use.

13.7.5 Safety Shoes. About 12,000 accidental foot injuries occur each year. Steel-reinforced shoes are designed to protect feet from common machine accidents - falling or rolling objects, cuts, and punctures. The entire toe box and insole are ordinarily reinforced.

Safety boots offer more protection from splash. Neoprene or nitrile boots are often required when handling caustics, solvents, or oils. Quick-release fasteners may permit speedy removal in case a hazardous substance gets in the boot. Slip-resistant soles are required for both shoes and boots, if a slip hazard is present.

13.7.6 Respirators/Ventilation. Respiratory hazards can be minimized by a good ventilation system. Note that respiratory protection is considered a secondary line of defense to protect the worker when ventilation cannot control exposures.

a) Further protection can be provided by one of the following types of respirator:

(1) Disposable dust masks/filters (fiber masks over nose and mouth filter particulates)

(2) Half masks - fits over nose and mouth; cartridges absorb or trap the contaminate; select the appropriate cartridge for the particulate (dust) or vapor

(3) Full face mask (they also protect eyes and face; vapors absorbed by canisters or cartridges; may also have dust filter)

(4) Air-supplied respirators (air from line or self-contained; positive air pressure in helmet or mask; provides greatest protection)

b) Personnel using respirators must do the following for full protection from respiratory hazards:

- respirator
- (1) Receive medical examination before wearing
 - (2) Receive knowledge of respiratory hazard
 - (3) Receive proper respirator training
 - (4) Get proper respirator fitting and testing
 - (5) Keep the respirator clean and properly stored
 - (6) Use the right respirator/cartridge for the job
 - (7) Receive periodic medical monitoring

13.8 Safety Program. A safety program should be a vital part of every shop conducting cleaning or painting operations. Each routine operation should have a standard operating procedure that includes a safety plan. Each non-routine operation should have a special operating plan that includes safety. Each worker should receive periodic training to keep him aware of pertinent Government regulations, potential health hazards, and measures that may be taken to minimize the hazards.

REFERENCES

NOTE: THE FOLLOWING REFERENCED DOCUMENTS FORM A PART OF THIS HANDBOOK TO THE EXTENT SPECIFIED HEREIN. USERS OF THIS HANDBOOK SHOULD REFER TO THE LATEST REVISIONS OF THE CITED DOCUMENTS UNLESS OTHERWISE DIRECTED.

FEDERAL/MILITARY SPECIFICATIONS, STANDARDS, HANDBOOKS, AND GUIDE SPECIFICATIONS:

Unless otherwise indicated, copies are available from the Naval Printing Service Detachment Office, Building 4D (Customer Service), 700 Robbins Avenue, Philadelphia, PA 19111-5094.

P-PUBLICATION

P-309 Colors for Navy Shore Facilities.

MILITARY HANDBOOK

MIL-HDBK-1004/10 Electrical Engineering Cathodic Protection.

MILITARY SPECIFICATIONS

MIL-B-131 Barrier Materials, Water Vaporproof, Greaseproof, Flexible, Heat-Sealable.

MIL-A-22262 Abrasive Blasting Media, Ship Hull Blast Cleaning.

MIL-P-24441 Paint, Epoxy-polyamide.

MIL-E-24635 Enamel, Silicone Alkyd Copolymer (Metric).

MIL-P-24647 Paint System, Anticorrosive and Antifouling, Ship Hull.

MIL-P-24648 Primer Coating, Zinc Dust Pigmented for Exterior Steel Surfaces (Metric).

MIL-E-24763 Enamel, Emulsion Type, for Shipboard Use.

MIL-P-28577 Primer, Waterborne, Acrylic or Modified Acrylic, for Metal Surfaces.

MIL-HDBK-1110

MIL-P-28578 Paint, Waterborne, Acrylic or Modified Acrylic, Semigloss, for Metal Surfaces.

MIL-P-28582 Primer Coating, Exterior, Lead Pigment-Free (Undercoat for Wood, Ready-Mixed, White and Tints)

MIL-E-29245 Epoxy Resin Systems for Concrete Repair.

MIL-P-53022 Primer, Epoxy Coating, Corrosion Inhibiting, Lead and Chromate Free.

MIL-C-85285 Coating: Polyurethane, High-Solids.

MIL-P-85582 Waterborne Epoxy Primer With 340 Grams per Liter Maximum VOC Content.

MILITARY STANDARD

DOD-STD-2138(SH) Metal Spray Coatings for Corrosion Protection Aboard Naval Surface Ships (Metric).

Lead-Based Paint (LBP) - Risk Assessment, Associated Health Risk in Children and Control of Hazards in DOD Housing and Related Structures.

FEDERAL SPECIFICATIONS

TT-B-1325 Beads (Glass Spheres) Retro-Reflective.

TT-C-555 Coating, Textured (for Interior and Exterior Masonry Surfaces).

TT-E-489 Enamel, Alkyd, Gloss, Low VOC Content.

TT-E-2784 Enamel (Acrylic-Emulsion, Exterior Gloss and Semigloss).

TT-P-19 Paint, Latex (Acrylic Emulsion, Exterior Wood and Masonry).

TT-P-25 Primer Coating, Exterior (Low VOC Undercoat for Wood, White and Tints).

TT-P-28 Paint, Aluminum, Heat Resisting (1200 Degrees F).

TT-P-29 Paint, Latex.

MIL-HDBK-1110

TT-P-31	Paint, Oil: Iron-Oxide, Ready-Mixed, Red and Brown.
TT-P-85	Paint, Traffic and Airfield Marking, Solvent Base.
TT-P-87	Paint: Traffic, Premixed, Reflectorized.
TT-P-95	Paint, Rubber: For Swimming Pools and Other Concrete and Masonry Surfaces.
TT-P-102	Paint, Oil (Alkyd Modified, Exterior, Low VOC).
TT-P-110	Paint, Traffic, Black (Nonreflectorized).
TT-P-115	Paint, Traffic (Highway, White and Yellow).
TT-P-645	Primer, Paint, Zinc-Molybdate, Alkyd Type.
TT-P-650	Primer Coating, Latex Base, Interior, White (for Gypsum Wallboard, or Plaster).
TT-P-664	Primer Coating, Alkyd, Corrosion-Inhibiting, Lead and Chromate Free, VOC-Compliant.
TT-P-1510	Paint, Latex, Exterior, for Wood Surfaces, White and Tints.
TT-P-1511	Paint, Latex (Gloss and Semigloss, Tints and White) (for Interior Use).
TT-P-1728	Paint, Latex Base, Interior, Flat, Deep-Tone.
TT-P-1952	Paint, Traffic and Airfield Marking, Water Emulsion Base.
TT-P-001984	Primer Coating, Latex Base, Exterior (Undercoat for Wood), White and Tints.

MIL-HDBK-1110

TT-P-002119 Paint, Latex-Base, High-Traffic Area,
Flat and Eggshell Finish (Low Lustre)
(for Interior Use).

TT-S-001992 Stain, Latex, Exterior for Wood
Surfaces.

FEDERAL STANDARDS

FED-STD-141 Paint, Varnish, Lacquer, and Related
Materials: Methods of Inspection,
Sampling, and Testing.

Method 3011.2, Condition in Container
Method 6271.2, Mildew Resistance.

FED-STD-595 Colors Used in Government Procurement.

COMMERCIAL ITEM DESCRIPTIONS

A-A-50542 Coating System: Reflective, Slip-
Resistant, Chemical-Resistant Urethane
for Maintenance Facility Floors.

NAVFAC GUIDE SPECIFICATIONS

NFGS-02761 Pavement Markings.

NFGS-02821 Chain Link Fences and Gates.

NFGS-09900 Paints and Coatings.

NFGS-09967 Coating of Steel Waterfront Structures.

NFGS-09970 Interior Coatings for Welded Steel Tanks
(for Petroleum Fuels).

NFGS-09971 Exterior Coating System for Welded Steel
Petroleum Storage Tanks.

NFGS-09973 Interior Coating System for Welded Steel
Petroleum Storage Tanks.

NFGS-09980 Interior Linings for Concrete Storage
Tanks (for Petroleum Fuels).

NFGS-13112 Cathodic Protection System (Steel Water
Tanks).

MIL-HDBK-1110

NFGS-13217	Fiberglass-Plastic Lining for Steel Tank Bottoms (for Petroleum).
NFGS-13219	Cleaning Petroleum Storage Tanks.
NFGS-13283	Removal and Disposal of Lead-Containing Paint.

OTHER GOVERNMENT PUBLICATIONS:

ARMY CORPS OF ENGINEERS GUIDE SPECIFICATIONS

CEGS 02090	Removal of Lead-Based Paint.
CEGS 02580	Joint Sealing in Concrete Pavements for Roads and Airfields.
CEGS 02831	Fence, Chain Link.
CEGS 09900	Painting, General.
CWGS 09940	Painting: Hydraulic Structures and Appurtenant Works.
CEGS 16641	Cathodic Protection System (Steel Water Tanks).
CWGS 16643	Cathodic Protection Systems (Impressed Current) for Lock Miter Gates.

ARMY TECHNICAL MANUAL

TM 5-807-7	Color for Buildings.
------------	----------------------

(Unless otherwise indicated, copies are available from the Naval Printing Service Detachment Office, Building 4D (Customer Service), 700 Robbins Avenue, Philadelphia, PA 19111-5094.

CENTER FOR DISEASE CONTRL (CDC)

Strategic Plan for Elimination of Childhood Lead Poisoning
1991 Strategic Plan.

(Unless otherwise indicated, copies are available from the Center for Disease Control (CDC), 4770 Buford Highway N.E., Mail Stop F-42, Room 1160, Atlanta, GA 30341-3724.)

DEPARTMENT OF HOUSING AND URBAN DEVELOPMENT (HUD)

Lead-Based Paint: Interim Guidelines for Hazard Identification and Abatement in Public and Indian Housing.

(Unless otherwise indicated, copies are available from

ENVIRONMENTAL PROTECTION AGENCY (EPA)

- | | |
|----------------|---|
| 40 CFR 50-99 | EPA National Ambient Air Quality Standards. |
| 40 CFR 60 | Method 24, Test Measuring VOC Content in Coatings—Appendix A. |
| 40 CFR 240-280 | |
| 40 CFR 261 | EPA Toxic Characteristic Leaching Procedure (TCLP)—Appendix II. |

(Unless otherwise indicated, copies are available from the Environmental Protection Agency (EPA), Public Affairs Office, Rockville, MD 20852; or the Superintendent of Documents, U.S. Government Printing Office, Washington, DC 20402.)

FEDERAL AVIATION ADMINISTRATION (FAA)

AC 70/7460-1G

(Unless otherwise indicated, copies are available from the Department of Transportation, FAA Aeronautical Center, AAC-492, P.O. Box 25082, Oklahoma City, OK 73125-5082.)

NATIONAL INSTITUTE OF STANDARDS AND TECHNOLOGY (NIST)

Standard Reference Material No. 1358, Certified Coating Thickness Calibration Standard.

(Unless otherwise indicated, copies are available from National Institute of Standards and Technology (NIST), Chief, Office of Standards Code and Information, Admin. Building 101, Room A629, Gaithersburg, MD 20879.)

OCCUPATIONAL SAFETY AND HEALTH ADMINISTRATION (OSHA)

- | | |
|----------------|-------------------------|
| 29 CFR 1910.25 | Portable Wood Ladders. |
| 29 CFR 1910.26 | Portable Metal Ladders. |

MIL-HDBK-1110

29 CFR 1910.28	Safety Requirements for Scaffolding.
29 CFR 1910.29	Manually Propelled Ladder Stands and Scaffolds (Towers).
29 CFR 1910.106/ 29 CFR 1926.152	Flammable and Combustible Liquids.
29 CFR 1910. 146	Permit-Required Confined Spaces.
29 CFR 1910.151	Medical Services and First Aid.
29 CFR 1910. 1200/ 29 CFR 1926.59	Hazard Communication.
29 CFR 1926.62	

(Unless otherwise indicated, copies are available from the Superintendent of Documents, U.S. Government Printing Office, Washington, DC 20402.)

NON-GOVERNMENT PUBLICATIONS:

AMERICAN CONFERENCE OF GOVERNMENTAL INDUSTRIAL HYGIENISTS (ACGIH)

Threshold Limit Values for Chemical Substances and Physical Agents in the Workroom Environment.

(Unless otherwise indicated, copies are available from the American Conference of Governmental Industrial Hygienists (ACGIH),

AMERICAN SOCIETY FOR TESTING AND MATERIALS (ASTM)

ASTM D 522	Mandrel Bend Test of Attached Organic Coatings.
ASTM D 523	Specular Gloss.
ASTM D 823	Producing Films of Uniform Thickness of Paint, Varnish, and Related Products on Test Panels.
ASTM D 1186	Nondestructive Measurement of Dry Film Thickness of Nonmagnetic Coatings Applied to a Ferrous Base.
ASTM D 1212	Measurement of Wet Film Thickness of Organic Coatings.

MIL-HDBK-1110

ASTM D 1400	Nondestructive Measurement of Dry Film Thickness of Nonconductive Coatings Applied to a Nonferrous Metal Base.
ASTM D 1475	Density of Paint, Varnish, Lacquer, and Related Products.
ASTM D 2369	Volatile Content of Coatings.
ASTM D 2621	Infrared Identification of Vehicle Solids From Solvent-Reducible Paints.
ASTM D 3273	Resistance to Growth of Mold on the Surface of Interior Coatings in an Environmental Chamber.
ASTM D 3274	Evaluating Degree of Surface Disfigurement of Paint Films by Microbial (Fungal or Algal) Growth or Soil and Dirt Accumulation.
ASTM D 3359	Measuring Adhesion by Tape Test.
ASTM D 3363	Film Hardness by Pencil Test.
ASTM D 4128	Identification of Organic Compounds in Water by Combined Gas Chromatography and Electron Impact Mass Spectrometry.
ASTM D 4214	Evaluating Degree of Chalking of Exterior Paint Films.
ASTM D 4258	Surface Cleaning Concrete for Coating.
ASTM D 4259	Abrading Concrete.
ASTM D 4260	Acid Etching Concrete.
ASTM D 4261	Surface Cleaning Concrete Unit Masonry for Coating.
ASTM D 4262	pH of Chemically Cleaned or Etched Concrete Surfaces.
ASTM D 4263	Indicating Moisture in Concrete by the Plastic Sheet Method.
ASTM D 4285	Indicating Oil or Water in Compressed Air.

MIL-HDBK-1110

ASTM D 4414	Wet Film Thickness by Notch Gages.
ASTM D 4541	Pull-Off Strength of Coatings Using Portable Adhesion Testers.
ASTM D 4840	Sampling Chain of Custody Procedures.
ASTM D 4940	Conductimetric Analysis of Water Soluble Ionic Contamination of Blasting Abrasives.
ASTM D 5043	Field Identification of Coatings.
ASTM E 667	Clinical Thermometers (Maximum Self-Registering, Mercury-in-Glass).
ASTM F 1130	Inspecting the Coating System of a Ship.

(Unless otherwise indicated, copies are available from the American Society for Testing and Materials (ASTM), 1916 Race Street, Philadelphia, PA 19103.)

MAPLE FLOORING MANUFACTURERS ASSOCIATION (MFMA)

Heavy Duty and Gymnasium Finishes for Maple, Beech, and Birch Floors.

(Unless otherwise indicated, copies are available from the Maple Flooring Manufacturers Association (MFMA), 60 Revere Drive, Suite 500, Northbrook, IL 60062.)

NATIONAL ASSOCIATION OF CORROSION ENGINEERS (NACE)

NACE No. 1	White Metal Blast.
NACE No. 2	Near-White Blast.
NACE No. 3	Commercial Blast.
NACE No. 4	Brush-Off Blast.
NACE RP0188	Standard Recommended Practice, Discontinuity (Holiday) Testing of Protective Coatings.
NACE TM0170	Visual Standard for Surfaces of New Steel Air Blast Cleaned With Sand Abrasive.

NACE TM0175 Visual Standard for Surfaces of New
Steel Centrifugally Blast Cleaned
With Steel Grit and Shot.

(Unless otherwise indicated, copies are available from the
National Association of Corrosion Engineers, P.O. Box 218340,
Houston, TX 77218.)

NATIONAL SANITATION FOUNDATION (NSF) INTERNATIONAL

NSF 60 Drinking Water Treatment Chemicals -
Health Effects.

NSF 61 Drinking Water System Components -
Health Effects.

(Unless otherwise indicated, copies are available from National
Sanitation Foundation (NSF) International, 3475 Plymouth Road,
P.O. Box 1468, Ann Arbor, MI 48106.)

SOCIETY FOR NAVAL ARCHITECTS AND ENGINEERS

Abrasive Blasting Guide for Aged or Coated Steel Structures.

STEEL STRUCTURES PAINTING COUNCIL (SSPC)

Steel Structures Painting Manual, Volume 2, Systems and
Specifications.

SSPC Guide 6I (CON) Containment of Lead-Based Paints.

SSPC Guide 7I (DIS) Disposal of Lead-Contaminated Surface
Preparation Debris.

SSPC Guide 23 Coating Systems.

SSPC AB 1 Mineral and Slag Abrasives.

SSPC PA 1 Shop, Field, and Maintenance Painting.

SSPC PA 2 Measurement of Dry Paint Thickness With
Magnetic Gages.

SSPC PA 3 Safety in Paint Application.

SSPC PAINT 16 Coal Tar Epoxy-Polyamide Black (or Dark
Red).

SSPC PAINT 24 Latex Semi-gloss Exterior Topcoat.

MIL-HDBK-1110

SSPC PAINT 25	Red Iron Oxide, Zinc Oxide, Raw Linseed Oil and Alkyd Primer.
SSPC QP 2	Evaluating the Qualifications of Painting Contractors to Remove Hazardous Paint.
SSPC SP 1	Solvent Cleaning.
SSPC SP 2	Hand Tool Cleaning.
SSPC SP 3	Power Tool Cleaning.
SSPC SP 5	White Metal Blast Cleaning.
SSPC SP 6	Commercial Blast Cleaning.
SSPC SP 7	Brush-off Blast Cleaning.
SSPC SP 8	Pickling.
SSPC SP 10	Near-White Blast Cleaning.
SSPC SP 11	Power Tool Cleaning to Bare Metal.
SSPC SP COM	Surface Preparation Commentary.
SSPC VIS 1	Abrasive Blast Cleaned Steel (Standard Reference Photographs).
SSPC VIS 3	Power- and Hand-Tool Cleaned Steel.

(Unless otherwise indicated, copies are available from the Steel Structures Painting Council (SSPC), 4516 Henry Street, Suite 301, Pittsburgh, PA 15213-3728.)

GLOSSARY

Painting operations often use terms that are peculiar to this field and, as such, may require some explanation or definition. This glossary is designed to provide the reader with some basic understanding of terms commonly used in painting and thus, eliminate possible misunderstandings resulting from conflicting interpretations of terms and improve communication between persons involved in the painting operation.

Abrasion. Act of being worn away.

Abrasive. Material used for abrasive blast cleaning; for example, sand, grit, steel shot, etc.

Absorption. Process of soaking up, or assimilation of one substance by another.

Accelerator. Catalyst; a chemical material which accelerates the hardening of certain coatings.

Acetone. A fast evaporating, highly flammable organic solvent.

ACGIH. American Conference of Governmental Industrial Hygienists.

Acoustic Paint. Paint which absorbs or deadens sound.

Acrylic Resin. A clear resin derived from polymerized esters of acrylic acids and methacrylic acid, often used in water-based paints, e.g., TT-P-19.

Activator. Catalyst or curing agent; accelerator.

Adhesion. Bonding strength; adherence of coating to the surface to which it is applied.

Agglomeration. Formation of masses or aggregates of pigments; not dispersed.

Air Bubble. Bubble in paint film caused by entrapped air.

Air Cap. Housing for atomizing air at head of spray gun.

Airless Spraying. Spraying using hydraulic pressure to atomize paint.

Air Manifold. Device that allows common air supply chamber to supply several lines.

Air Quality Control Regions. Geographical units of the country, as required by U.S. law reflecting common air pollution problems, for purpose of reaching national air quality standards, for example California's South Coast Air Quality District.

Alcohols. Flammable solvents; alcohols commonly used in painting are ethyl alcohol (ethanol) and methyl alcohol (methanol, wood alcohol).

Aliphatic Polyurethane. Type of polyurethane resin resistant to ultraviolet light.

Aliphatic Solvent. Weak organic solvent, such as mineral spirits.

Alkali. Caustic, strong base, high pH, such as sodium hydroxide, lye, etc.

Alkyd Resins. Resins prepared from polyhydric alcohols and polybasic acids.

Alligatoring. Surface imperfections of paint having the appearance of alligator hide.

Ambient Temperature. Temperature or temperature of surroundings.

American Gallon. 231 cubic inches, 3.8 liters.

Amides. Possible curing agent for epoxy resins.

Amines. Possible curing agent for epoxy resins.

Anchor Pattern. Profile or texture of surface, usually attained by blasting.

Anhydrous. Dry, free of water in any form.

ANSI. American National Standards Institute.

Antifouling Coating. Coating with toxic material to prevent attachment and growth of marine fouling organisms.

Arcing. Swinging spray gun or blasting nozzle in arc at different distances from substrate.

Aromatic. Type of polyurethane with good chemical resistance but poor urethane ultraviolet resistance.

Aromatic Solvents. Strong organic solvents, such as benzene, toluene, and xylene.

Asphalt. Residue from petroleum refining; also a natural complex hydrocarbon.

ASTM. American Society for Testing and Materials.

Atomize. Break steam of liquid into small droplets.

Baking Finish. Paint product requiring heat cure, e.g., as used on factory coated metal siding.

Barrier Coating. Coating that protects by shielding substrate from the environment.

Batch. Industrial unit or quantity of production used in one complete operation.

Binder. Resin; non-volatile vehicle; film forming portion of paint, such as oil, alkyd, latex emulsion, epoxy, etc.

Bituminous Coating. Coal tar or asphalt based coating.

Blast Angle. Angle of blast nozzle to surface; also angle of particle propelled from rotating blast cleaning wheel with reference to surface.

Blast Cleaning. Cleaning with propelled abrasives.

Bleaching. Removing color.

Bleeding. Penetration of color from the underlying surface to surface of existing paint film, e.g., brown color from asphalt coatings.

Blisters. Bubbles in film, areas in which film has lost adhesion to substrate.

Blocking. Undesirable sticking together of two painted surfaces when pressed together under normal conditions.

Blooming. Whitening of surface of paint film; moisture blush; blushing.

Blow-back (Spray Term). Term relating to rebounding of atomized sprayed droplets.

Blushing. Whitening and loss of gloss of paint film due to moisture or improper solvent balance.

Body. Consistency; to thicken.

Bonding. Adhesion.

Bounce-back. Rebound of paint spray particles, similar to blow-back.

Boxing. Mixing of paint by pouring back and forth from one container to another.

Bridging. Forming a skin over a depression, crack, inside corner, etc.

Broadcast. To sprinkle solid particles on a surface.

Brush-off Blast. Degree of blast cleaning in which surface is free of visible oil, grease, dirt, dust, loose mill scale, loose rust, and loose paint; SSPC SP 7, NACE No. 4, Brush-off Blast.

Bubbling. A term used to describe the formation of blisters on the surface while a coating is being applied.

Burnish. To polish or rub to a smoother or glossier surface.

Caking. Hard settling of pigment from paint.

Catalyst. Accelerator; curing agent; promoter.

CCB. Construction Criteria Base.

CDC. Center for Disease Control.

Cellosolve. Proprietary name for the monoethyl ether of ethylene glycol, used as a solvent in paints.

CEGS. Corps of Engineers Guide Specification.

CERL. Construction Engineering Research Laboratory.

CFR. Code of Federal Regulations.

Chalking. Powdering of surface of paint film.

Checking. Formation of slight breaks in the topcoat that do not penetrate to the underlying paint films.

Chlorinated. Type of resin used as a paint binder that cures by solvent rubber evaporation.

CID. Commercial item description.

Coal Tar-Epoxy Paint. Paint in which binder or vehicle is a combination of coal tar with epoxy resin.

Coatings. Surface coverings; paints; barriers.

Cobwebbing. A spider web effect on surface of film caused by premature drying of sprayed paint.

Cohesion. Property of holding self together.

Cold-checking. Checking of film caused by low temperatures.

Color-fast. Non-fading.

Color Retention. Ability to retain original color.

Commercial Blast. Degree of blast cleaning in which surface is free of visible oil, grease, dirt, dust, loose mill scale, loose rust, and loose paint; SSPC SP 6, NACE No. 2, Commercial Blast.

Compatibility. Ability to mix with or adhere properly to other component or substances.

Continuity. Degree of being intact or pore-free.

Conversion Coating. System used to convert rusted surface to one that is paintable without abrasive or mechanical cleaning.

Conversion Treatment. Treatment of metal surface to convert it to another coating chemical form, e.g., a phosphate on steel.

Copolymer. Large molecule resulting from simultaneous polymerization of different monomers.

Corrosion. Oxidation of material; deterioration due to interaction with environment.

CPVC. Critical pigment volume concentration.

CQC. Contractor quality control.

Cracking. Splitting, disintegration of paint by breaks through film to substrate.

Cratering. Formation of holes or deep depressions in paint film as paint film dries.

Crawling. Shrinking of paint to form uneven surface shortly after application.

Crazing or Cracking. Development of non-uniform surface appearance of myriad tiny scales as a result of weathering.

Cross-linking. A particular method by which molecules unite to form films.

Cross-spray. Spraying first in one direction and then at right angles.

CSI. Construction Specification Institute.

Curing. Setting-up or hardening of paint film.

Curing Agent. Hardener; promoter.

Curtaining. A kind of sagging or running of paint when applied.

Deadman Valve. Valve at blast nozzle for starting and automatic shutoff of abrasive flow.

Degreaser. Chemical (i.e., solvent or detergent solution) for grease and oil removal.

Delamination. Separation and peeling of one or more layers of paint from underlying substrate.

Density. Weight per unit volume.

Descaler. Tool used to remove heavy scale.

Detergent. Cleaning agent.

Dew Point. Temperature at which moisture condenses.

DFT. Dry film thickness.

Diluents. Thinners; reducer.

Dispersion. Suspension of one substance in another.

Distillation. Purification or separation by liquid volatilization and condensation.

Doctor Blade. Knife applicator for applying paint of fixed film thickness.

Drawdown. Preparation of a paint film of a fixed uniform thickness using a doctor blade.

Drier. Chemical which promotes oxidation or drying of paint, particularly those made with oils.

Dry Film. Thickness of applied coating when dry, thickness usually expressed in mils (1/1000 inch).

Dry Spray. Overspray or bounce-back; sandy or pebbly finish due to spray particle being partially dried before reaching the surface.

Drying Oil. An oil which hardens in air.

Drying Time. Time interval between application and a specified condition of dryness.

Dry to Recoat. Time interval between application and ability to receive next coat satisfactorily.

Dry to Touch. Time interval between application and ability to be touched lightly without damage (tack-free time).

DTM. Direct to metal coating (self-priming).

Dulling. Loss of gloss or sheen.

Efflorescence. Powdery white to gray soluble salts deposited on surface of brick and other masonry.

Eggshell. Paint having gloss between semi-gloss and flat; paint having high sheen.

Elasticity. Degree of recovery from stretching.

Electrostatic Spray. Spraying with electrically charged paint and substrate to attract paint to surface.

Emulsion Paint. Water-thinned paint with resin or latex vehicle dispersed in water.

Enamel. A paint which is characterized by an ability to form an especially smooth and usually glossy film.

EPA. Environmental Protection Agency.

Epoxy Resins. A type of resin; film formers usually made from bisphenol A and epichlorohydrin.

Erosion. Wearing away of paint films to expose the substrate or undercoat.

Etch. Surface preparation of metal by chemical means.

Evaporation Rate. Rate at which a solvent evaporates.

Explosive Limits. A range of the ratio of solvent vapor to air in which the mixture will explode if ignited. Below the lower or above the higher explosive limit, the mixture is too lean or too rich to explode. The critical ratio runs from about 1 to 12 percent of solvent vapor by volume at atmospheric pressure.

Extender Pigment. Pigment which can contribute specific properties to paint, generally low in cost.

External Mix Nozzle. Spray nozzle in which the paint and air are mixed outside the gun.

FAA. Federal Aviation Administration.

Fading. Reduction in brightness of color or change in color of paint film as a result of weathering.

Fan Pattern. Geometry or shape of spray pattern.

Feathered Edge. Tapered edge.

Feathering. (1) triggering a gun at the end of each stroke; (2) tapering edge of paint film adjacent to peeled area.

Ferrous. Iron.

Field Painting. Painting at the job site.

Filler. Extender; building agent for paint; inert pigment.

Film Build. Thickness of one coat of paint.

Film-former. Paint component that cures to form a dry film; binder; resin.

Film Integrity. Degree of continuity of film.

Film Thickness Gage. Device used for measuring film thickness; both wet and dry gages are available.

Filter. Strainer; purifier.

Fineness of Grind (Dispersion). Measure of pigment size or roughness of liquid paint; degree of dispersion of pigment in the binder.

Fire-Retardant Paint. Paint which will delay flaming or overheating of substrate.

Fish Eye. Pulling apart of paint film similar to cratering to form holes.

Flaking. Disintegration of dry film into small pieces or flakes; see scaling.

Flammability. Measure of ease of catching fire; ability to burn.

Flash Point. The lowest temperature at which a given flammable material will flash if a flame or spark is present.

Flash Rusting. Rusting of steel after cleaning, particularly in humid environments or after wet blasting.

Flatting. Loss of gloss in coating film.

Flexibility. Elongation; ability to bend without damage.

Floating. Separation of pigment colors on surface of paint film.

Flooding. Floating; separation of pigment colors on surface of paint.

Flow. A property of self-leveling.

Fog Coat. Thin or mist coat (about 1/2 mil dry film thickness).

FTIR. Fourier transform infrared.

Fungicide. Mildewcide; toxic chemical to control fungal growth.

Galvanized Steel. Zinc-coated steel, usually by dipping in a bath of molten zinc.

Generic. Basic class or type; generic type of paint is denoted by the type of resin present.

Gloss. Luster; sheen; brightness.

Graffiti-Resistant Coating. Coating from which graffiti can be removed by scrubbing.

Grit. Abrasive from slag and other sources used in blast cleaning.

Grounding. Dissipation of electric charge.

GSA. General Services Administration.

Hardener. Catalyst; curing agent.

Hazing. Clouded appearance.

Hegman Number. Measure of fineness of grind or dispersion of pigment into the vehicle.

Hiding Power. Ability of paint film to obscure underlying surface.

High Build Coating. Coating that can be applied so as to obtain a thick film in one coating application.

Hold out. Ability to prevent nonuniform soaking into the substrate resulting in a nonuniform appearing film.

Holiday. Pinhole, skip, or other discontinuity in paint film.

HUD. Department of Housing and Urban Development.

HVLP. High-volume, low-pressure.

Humidity. Measure of moisture content; relative humidity is the ratio of the quantity of water vapor in the air compared to the greatest amount possible at a given temperature. Saturated air has a humidity of 100 percent.

Hydroblasting. Water blasting; cleaning a surface with water at extremely high pressures.

Hydrolysis. Chemical reaction in which a compound, such as an oil resin, is split into two parts by reaction with water; see saponify.

Impermeable. Restricting the passage of moisture, air or other substance.

Incompatibility. Inability of a coating to perform well over another coating because of bleeding, poor bonding, or lifting of old coating; inability of coating to perform well on a substrate.

Induction Time. Time interval required between mixing of components and application of two or more component paints to obtain proper application properties.

Indicator Paper (pH). Vegetable dyed paper indicating relative acidity or paper basicity (alkalinity).

Inert Pigment. A non-reactive pigment.

Inhibitive Primer. Primer pigment that retards the corrosion process.

Inorganic Silicate or Coating. Those employing inorganic binders or vehicles such as phosphate rather than organic, that is those of petroleum, animal, or plant origin.

IPM. In-place management.

Internal Mix Nozzle. Spray nozzle in which the fluid and air are combined before leaving gun.

Intumescent Ignition. Fire-retardant coating that forms a voluminous char on coating.

Ketones. Flammable organic solvents; commonly used ketones are acetone; methyl ethyl ketone (MEK); and methyl isobutyl ketone (MIBK).

Krebs Unit (KU). Arbitrary unit for measuring viscosity.

Lacquers. Coatings which dry by solvent evaporation.

Laitance. White to gray deposit on surface of new concrete.

Latex. Natural or synthetic binder for emulsion (water) paints.

LBP. Lead-based paint.

Leafing. Orientation of pigment flakes in wet paints in horizontal planes to increase impermeability of dry film.

Leveling. Flowing of paint to form films of uniform thickness; tendency of brush marks to disappear.

Lifting. Softening and raising of an undercoat by application of a top coat.

Livering. Condition of paint in can having curds or gelling.

Low Pressure Spraying. Conventional air spraying.

Mastic. Heavy-bodied, high build coating.

MEK. Methyl ethyl ketone, strong flammable organic solvent.

MFMA. Maple Flooring Manufacturers Association.

MIBK. Methyl isobutyl ketone.

Mil. 0.001 inch.

Micron. Micrometer, 0.001 of a millimeter.

Mildewcide. Toxic chemical added to paint to control mildew.

Mill Scale. Bluish layer of iron oxide formed on surface of steel by hot rolling.

Mistcoat. A thin (about 1/2 mil dry film thickness) coat applied to existing paint for bonding of a subsequently applied coat.

MSDS. Material safety data sheet, described in Section 13.

Mud Cracking. Irregular cracking of dried paint resembling cracked mud, usually caused by paint being too thick.

NACE. National Association of Corrosion Engineers.

Naphtha. Flammable aliphatic hydrocarbon (weak) solvent.

Near White Blast. Grade of blast cleaning in which surface is free of visible oil, grease, dirt, dust, mill scale, rust paint oxides, corrosion products, and other foreign matter, except for staining; SSPC SP 10, NACE No. 2, Near-White Blast.

NFGS. Naval Facilities Engineering Command Guide Specification.

NIOSH. National Institute of Safety and Hygiene.

NIST. National Institute of Standards and Technology.

Nonvolatile Vehicle. Resin; binder; film-forming component of paints.

NRR. Noise reduction rating.

NSF. National Sanitation Foundation.

Oleoresinous. Vegetable or fish oil resin that cures by air oxidation.

Opacity. Hiding power; ability to obscure underlying surface.

Orange Peel. Hills and valleys in paint resembling the skin of an orange.

Organic Coating. Coating with organic binder, generally of petroleum or vegetable origin.

OSHA. Occupational Safety and Health Administration.

Overcoat. Top coat.

Overlap. Portion (width) of fresh paint covered by next layer.

Overspray. Dry spray, particularly such paint that failed to hit target.

Paint. Coating materials used in painting.

Paint Heater. Device for lowering viscosity of paint by heating.

Paint Program. Comprehensive painting plan.

Paint System. Surface preparation, and the complete number and type of coats comprising a paint job.

Pass (Spray). Motion of spray gun in one direction.

Peeling. Failure in which paint curls or otherwise strips from substrate.

Perm. Unit of permeance; grains of water vapor per hour per square foot per inch of mercury-water vapor pressure difference.

Phosphatize. To form a thin inert phosphate coating on surface usually by treatment with phosphoric acid or other phosphate compound.

pH Value. Measure of acidity or alkalinity; pH 7 is neutral; the pH values of acids are less than 7, and of alkalies (bases), greater than 7.

Pickling. A dipping process of cleaning steel and other metals; the pickling agent is usually an acid; SSPC SP 8.

Pigment. Solid, opaque, frequently colored component of paint.

Pigment Grind. Dispersing of pigment in vehicle.

Pigment Overload. Mottle surface from too much pigmentation.

Pigment Volume Concentration (PVC). Percent by volume occupied by pigment in wet paint.

Pitting. Formation of small, deep or shallow cavities formed in steel by rusting.

Pinholing. Formation of small holes through coating from improper application.

Plasticizer. Paint component added to increase flexibility.

Polyvinyl Acetate (PVA). Synthetic resin used extensively in emulsion (water) paints.

Polymer. Large molecule formed by reaction of smaller molecules; used to make synthetic resins.

Pot Life. Time interval after mixing of components during which the coating can be satisfactorily applied.

Primer or Prime Coat. First coat on a substrate usually containing inhibitive pigments when formulated for use on metals.

Profile. Surface texture, particularly of abrasive blast cleaned steel.

Proprietary. Commercially available under a brand name.

Psychrometer. Instrument for measuring humidity.

PVC. Pigment volume concentration; pigment concentration by volume in the whole paint.

QC. Quality control.

RCRA. Resource Conservation and Recovery Act.

Rebound. Paint spray bounce-back.

Reducer. Thinner; solvent added to reduce paint viscosity for easier application.

Resin. Binder; nonvolatile vehicle; film-forming component of paints.

Run. Sag; curtain; associated with too heavy a paint film.

Rust. Corroded iron; red iron oxide deposited on metal.

Rust Bloom. Discoloration indicating the beginning of rusting.

Safety Valve. Pressure release valve preset to be released when pressure exceeds a safe operating limit.

Sag. Run in coating film; curtain.

Sand Blast. General term used to mean blast cleaning; blast cleaning using sand as an abrasive.

Sandy Finish. A surface condition having the appearance of sandpaper; may result from overspray or dry spray.

Saponify. Chemical reaction between some resins (e.g., oil and alkyds) and alkaline solutions converting resin to soaps. Saponified paint may become sticky and lose adhesion to substrate. See also hydrolysis.

Scale. Heavy layer of iron oxide on surface of steel, could be rust or mill scale; see also mill scale.

Scaling. Process of removing scale.

Seal Coating. Coating used to prevent excessive absorption of the first coat of paint by the substrate; a primer.

Sealer. A low viscosity (thin) liquid sometimes applied to wood, plaster, gypsum board, concrete, or masonry to reduce permeability.

SEM. Scanning electron microscope.

Settling. Caking of paint pigments in wet paint; sediment.

Sheen. Appearance characteristic of dry film in which film appears flat when viewed at an angle near to perpendicular and glossy when viewed at an angle near to grazing, such as 85 degrees.

Shelf-Life. Maximum interval in which a material may be stored and still be in usable condition.

Shop Coat. Coating applied in fabricating shop.

Shot Blasting. Blast cleaning using steel shot as the abrasive.

Silicate Paints. Those employing silicates as binders; used primarily in inorganic zinc-rich coatings.

Silicone Resins. A particular group of film formers; used in water-repellent and high-temperature paints.

Silking. A surface defect characterized by parallel hair-like striations in dry coating films.

Skinning. Formation of a solid membrane on top of liquid paint.

Skips. Holidays; misses; uncoated area; voids.

Sling Psychrometer. Instrument to measure relative humidity consisting of dry/wet bulb thermometers suitably mounted for swinging through the air.

Solids By Volume. Percentage of total volume of wet paint occupied by non-volatile compounds.

Solubility. Degree to which a substance may be dissolved.

Solution. A liquid in which a substance (solute) is dissolved in a solvent.

Solvent. A liquid in which another substance may be dissolved; thin liquid used to add to paint to reduce viscosity.

Solvent Balance. Ratio of amounts of different solvents in a mixture of solvents.

Solvent Pop. Blistering of paint film caused by entrapped solvent.

Solvent Wash. Cleaning surface to be painted with solvent.

Stalling. The cracking, breaking, or splintering of the surfaces of substrates, such as cinder block, from the bulk material.

Spreading Rate. Area covered by a unit volume of paint at a specific thickness.

SSPC. Steel Structures Painting Council.

STEL. Short-term exposure limit.

TCLP. Toxic characteristic leaching procedure.

Thermoplastic. Paint softened by heat or solvent (type of one-component coating made up of high molecular resins which dry/cure by solvent evaporation, e.g., vinyls).

Thermosetting. Paint that cures by undergoing a chemical reaction leading to a relatively insoluble material (e.g., epoxies, polyurethanes).

Thinner. Reducer; solvent added to reduce paint viscosity for easier application.

Thixotropic. Paint of gel consistency in the can that becomes a liquid paint when stirred or brushed but becomes a gel again upon standing.

Through Drying. Curing of paint film through the entire thickness as opposed to curing only on the surface.

Tiecoat. Thin coat applied to a cured paint to enhance the bonding of a topcoat.

TLV. Threshold limit value.

Tooth. Profile; mechanical anchorage; surface roughness.

Top Coat. Finish coat.

Triggering. Intermittent squeezing and releasing of spray gun trigger.

TWA. Time weighted average.

Ultraviolet Radiation. Portion of sunlight having a shorter wavelength than visible light.

Undercutting. Blistering and/or peeling of paint from underfilm corrosion in areas of a paint defect.

Urethane Resins. A particular group of film formers.

Useful Life. The length of time a coating is expected to remain in service.

UV. Ultraviolet.

VM&P Naphtha. Varnish and paint manufacturers naphtha; a low power flammable hydrocarbon solvent.

Vapor Degreasing. A cleaning process utilizing condensing solvent as the cleaning agent, usually done in a shop.

Vaporization. Conversion of material from liquid to a gaseous state.

Varnish. Liquid composition which converts to a transparent or translucent solid film after application as a coating.

Vehicle. Liquid portion of paint; binder or resin and solvent components of paint.

Venturi Nozzle. Blast nozzle with tapered lining for increased blasting speed and a large, more uniform blast pattern.

Vinyl Coating. One in which the major portion of the binder is of a vinyl resin.

Viscosity. Consistency; a measure of fluidity.

VOC. Volatile organic compound.

Volatiles. Fluids which evaporate rapidly.

Volatile Content. Amount of materials which evaporate when paint cures; usually expressed as a percentage.

Volatile Organic Compound (VOC). As defined by California Air Quality Districts, excluding carbon monoxide, carbon dioxide, carbonic acid, metallic carbides or carbonates, ammonium carbonate, methane, 1,1,1-trichloroethane, methylene chloride, and trichlorotrifluoroethane, are compounds which may be emitted to the atmosphere during the application of and/or subsequent drying or curing of coatings.

Wash Primer. A thin rust-inhibiting primer with phosphoric acid and rust inhibitor which provides improved adhesion to subsequent coats.

Water Blasting. Blast cleaning using high velocity water.

Weld Spatter. Beads of metal left adjoining a weld.

Wet Edge. Fluid boundary.

Wet Film Gage. Device for measuring wet film thickness.

White Metal Blast. Highest degree of cleaning, when surface is viewed without magnification it is free of visible oil, grease, dirt, dust, mill scale, rust, paint, oxides, corrosion products, and other foreign matter; SSPC SP 5, NACE No. 1, White Metal Blast.

Wrinkling. Rough, crinkled surface, usually related to surface skinning over uncured paint.

CUSTODIAN
NAVY - YD2

PREPARING ACTIVITY
NAVY - YD2

PROJECT NO.
FACR-1131

STANDARDIZATION DOCUMENT IMPROVEMENT PROPOSAL

INSTRUCTIONS

1. The preparing activity must complete blocks 1, 2, 3, and 8. In block 1, both the document number and revision letter should be given.
2. The submitter of this form must complete blocks 4, 5, 6, and 7.
3. The preparing activity must provide a reply within 30 days from receipt of the form.

NOTE: This form may not be used to request copies of documents, nor to request waivers, or clarification of requirements on current contracts. Comments submitted on this form do not constitute or imply authorization to waive any portion of the referenced document(s) or to amend contractual requirements.

I RECOMMEND A CHANGE:	1. DOCUMENT NUMBER MIL-HDBK-1110	2. DOCUMENT DATE (YYMMDD) 950117
3. DOCUMENT TITLE HANDBOOK FOR PAINTS AND PROTECTIVE COATINGS FOR FACILITIES		
4. NATURE OF CHANGE (identify paragraph number and include proposed rewrite, if possible. Attach extra sheets as needed.)		
5. REASON FOR RECOMMENDATION		
6. SUBMITTER		
a. NAME (Last, First, Middle Initial)	b. ORGANIZATION	
c. ADDRESS (Include Zip Code)	d. TELEPHONE (Include Area Code) (1) Commercial (2) DSN (If applicable)	7. DATE SUBMITTED: (YYMMDD)
8. PREPARING ACTIVITY		
a. NAME Commanding Officer Northern Division, Naval Facilities Engineering Command	b. TELEPHONE (Include Area Code) (1) Commercial (2) DSN (610) 595-0661 443-0661	
c. ADDRESS (Include Zip Code) ATTN Code 164 10 Industrial Highway, Mail Stop 82 Lester, PA 19113-2090	IF YOU DO NOT RECEIVE A REPLY WITHIN 45 DAYS, CONTACT: Defense Quality and Standardization Office 5203 Leesburg Pike, Suite 1403, Falls Church, VA 22041-3466 Telephone (703) 756-2340 DSN 289-2340	